

## Ethernet - DMX4 MkII Range

*User Guide - V4.x.x*



Luminex Network Intelligence  
Ethernet - DMX4 MkII Range User Guide - V4.x.x  
Document lu\_01\_00030\_4\_man

Copyright © 2003-2017 Luminex Network Intelligence.  
All rights reserved.

No part of this documentation may be reproduced or transmitted in any form or by any means, electronic or mechanical, including photocopying and recording, without the prior written permission of Luminex.

The information in this documentation is supplied without warranty of any kind, either directly or indirectly, and is subject to change without prior written notice. Luminex, its employees or appointed representatives will not be held responsible for any damages to software, hardware, or data, howsoever arising as a direct or indirect result of the product(s) mentioned herein.

Issued by:

Publications Department,  
Luminex LCE,  
Berkenlaan 8A,  
Hechtel - Eksel,  
B-3940,  
Belgium.

Documentation reviewed January 9, 2017, by Bart Swinnen.  
Printed in the EU.

## Table of Contents

Warranty information.....	5
Limited warranty.....	5
Returning under warranty.....	5
Freight.....	5
General.....	6
Packaging.....	6
Description.....	6
Specification.....	6
Dimensions.....	6
Weight.....	7
Electrical.....	7
Connectors.....	7
Environmental.....	7
Connectivity.....	8
Rear Panel – Side Panel.....	8
Mains.....	8
Interface.....	10
Front panel.....	10
Ethernet port.....	10
DMX input / output.....	10
Status indication.....	10
Front end display information.....	11
Reset the node (Out of jail).....	12
Web interface.....	13
Status.....	13
Setup.....	14
Node.....	14
DMX Routing.....	15
Merging Policies :.....	17
Inputs (Local mode).....	18
Inputs (IP Merging).....	20
Outputs (IP Merging).....	20
Recover channel.....	23
Network settings.....	25
IP Settings.....	25
Global.....	26
DMX details.....	26
Miscellaneous.....	28
Toolbox.....	29
Profile manager.....	29
Snapshot manager.....	30
Firmware upgrade.....	32
Toubleshooting.....	34
Additional Documentation.....	35
Credits:.....	35

## Warranty information

### ***Limited warranty***

Unless otherwise stated, your product is covered by a two (2) years parts and labor limited warranty. It is the owner's responsibility to furnish receipts or invoices for verification of purchase, date, and dealer or distributor. If purchase date cannot be provided, date of manufacture will be used to determine warranty period.

### ***Returning under warranty***

Any Product unit or parts returned to Luminex LCE must be packaged in a suitable manner to ensure the protection of such Product unit or parts, and such package shall be clearly and prominently marked to indicate that the package contains returned Product units or parts. Accompany all returned Product units or parts with a written explanation of the alleged problem or malfunction.

### ***Freight***

All shipping will be paid by the purchaser. Items under warranty shall have return shipping paid by the manufacturer only in the European Union. Under no circumstances will freight collect shipments be accepted. Prepaid shipping does not include rush expediting such as air freight. Air freight can be sent customer collect in the European Union.

Warranty is void if the product is misused, damaged, modified in any way, or for unauthorized repairs or parts.

## General

### **Packaging**

#### **- Ethernet-DMX4 MkII**

- 1 x Ethernet – DMX4 MkII
- 1 x User guide

#### **- Ethernet-DMX4 MkII Truss**

- 1 x Ethernet – DMX4 MkII Truss
- 1 x Powercon male connector
- 1 x User Guide

### **Description**

The Ethernet - DMX4 MkII is an Ethernet node that serves 4 x DMX512 outlets, compatible with the following protocols: DMX512, DMX512-A, RDM (ANSI E1.20), sACN (ANSI E1.31) and Art-Net™.

All 4 outlets can be used as input or output. The Ethernet links are 100BaseT connections on Neutrik RJ45 Ethercon connector, located on the front and the rear for the rack version, on the front and the side for the truss mounted version.

All configuration can be done over Ethernet through a built in website.

This all comes in a 19" unit high metal housing for the Ethernet-DMX4 MkII. The Ethernet-DMX4 Truss MkII comes in a rugged truss mountable metal housing with a M10 insert. This enclosure allows to use the node in a truss or as a table top device.

### **Specification**

Model: Ethernet – DMX4 MkII – Ethernet -DMX4 MkII Truss

Manufacturer: LUMINEX Lighting Control Equipment

#### **• Dimensions**

Ethernet-DMX4 MkII

482 x 183 x 44 (mm)  
19" x 7,2" x 1,73"  
Package: 520 x 235 x 50 (mm)

Ethernet-DMX4 MkII Truss

235 x 134,2 x 82 (mm)  
9,3" x 5,3" x 3,2"  
Package: 305 x 215 x 110 (mm)

- **Weight**

Ethernet-DMX4 MkII: 2,3 kg  
Ethernet-DMX4 MkII Truss: 2,3 kg

- **Electrical**

Voltages: 90 – 260 VAC  
Frequency: 47 – 63 Hz  
Rated power: Rack version : 20 W, Truss version: 15 W  
Fuse : 125V – 250V, 1A, Slow blow only (5mm x 20mm)

- **Connectors**

2 x shielded Neutrik RJ45 Ethercon connector  
(front and rear for Ethernet-DMX4 MkII, front and side for Ethernet-DMX4 MkII Truss)  
4 x shielded Neutrik gold plated 5 pin XLR (female)  
4 x optic and galvanic isolated DMX port  
1 x IEC inlet with fuse holder (Rack version only)  
1 x Neutrik Powercon inlet (Trus version only)

- **Environmental**

Operating temperature: 0 ~ 60°C (32 ~ 140°F)  
Storage temperature : -10 ~ 70°C (14 ~ 158°F)  
Humidity: 5-95% non condensing

## Connectivity

### Rear Panel – Side Panel

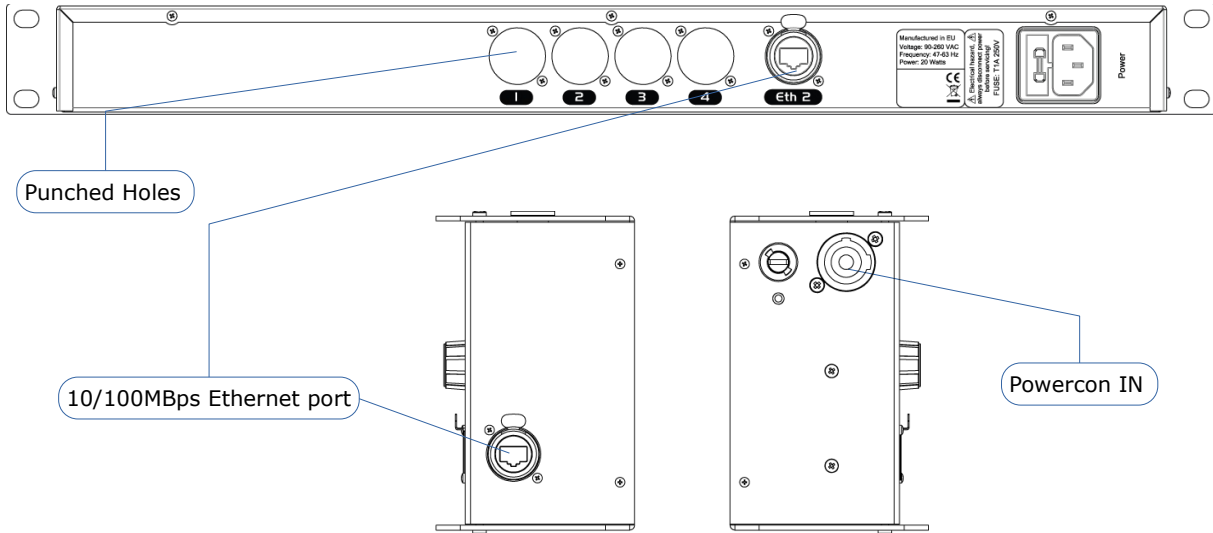

### Ethernet-DMX4 MkII

- **Mains**

The device operates with an AC voltage between 90V and 260V within a frequency range of 47Hz and 63Hz.

An IEC socket is located at the rear of the unit. Please use an IEC plug compliant cable to feed power to the unit.

Luminex recommend the use of a power cable, fitted with an IEC-Lock™ plug. The IEC-Lock™ system offers a reliable way to connect the power cable to the unit.

### **!!! This equipment must be earthed !!!**

- **Punched holes**

The unit offers 4 punched holes to easily install 4 optional DMX input connectors.

- **Ethernet**

1 Neutrik RJ45 Ethercon is provided as Ethernet link.

## Ethernet-DMX4 MkII Truss

The device operates with an AC voltage between 90V and 260V within a frequency range of 47Hz and 63Hz.

A Neutrik PowerCon IN connector can be connected to the device. Please use an authorized plug and connect the cores in the mains lead in accordance with the following scheme:

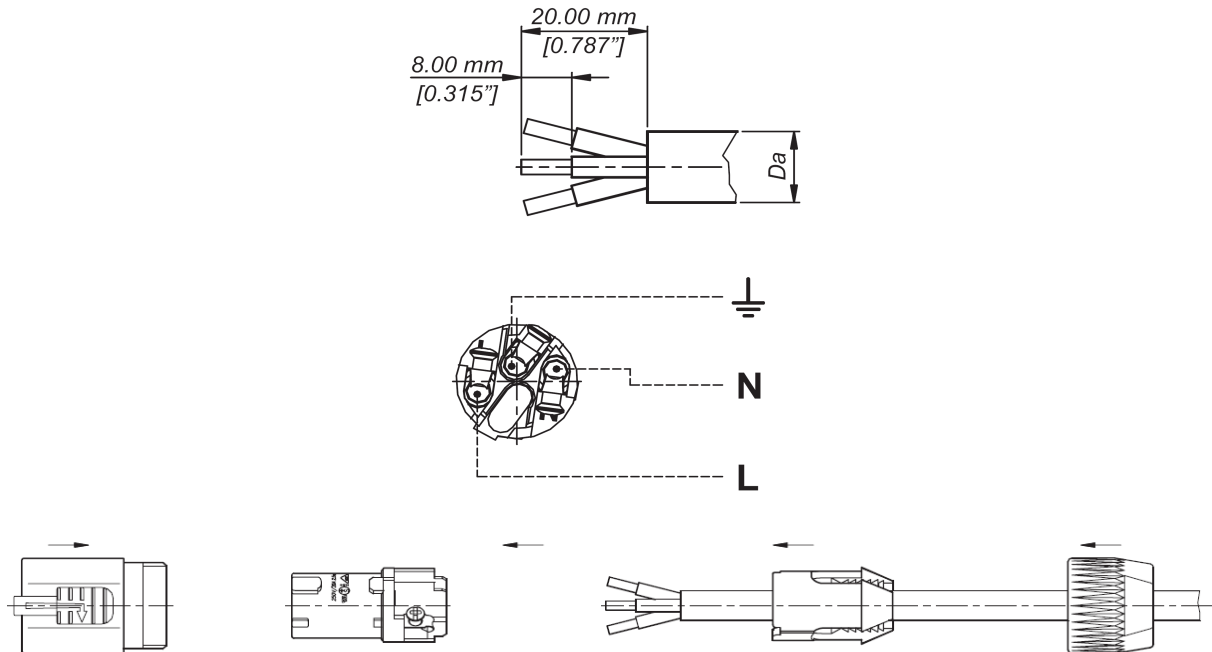

**Green / Yellow:** Earth  
**Blue:** Neutral  
**Brown:** Live

**!!! This equipment must be earthed !!!**

- **Ethernet**

1 Neutrik RJ45 Ethercon is provided as Ethernet link.



# Interface

## Front panel

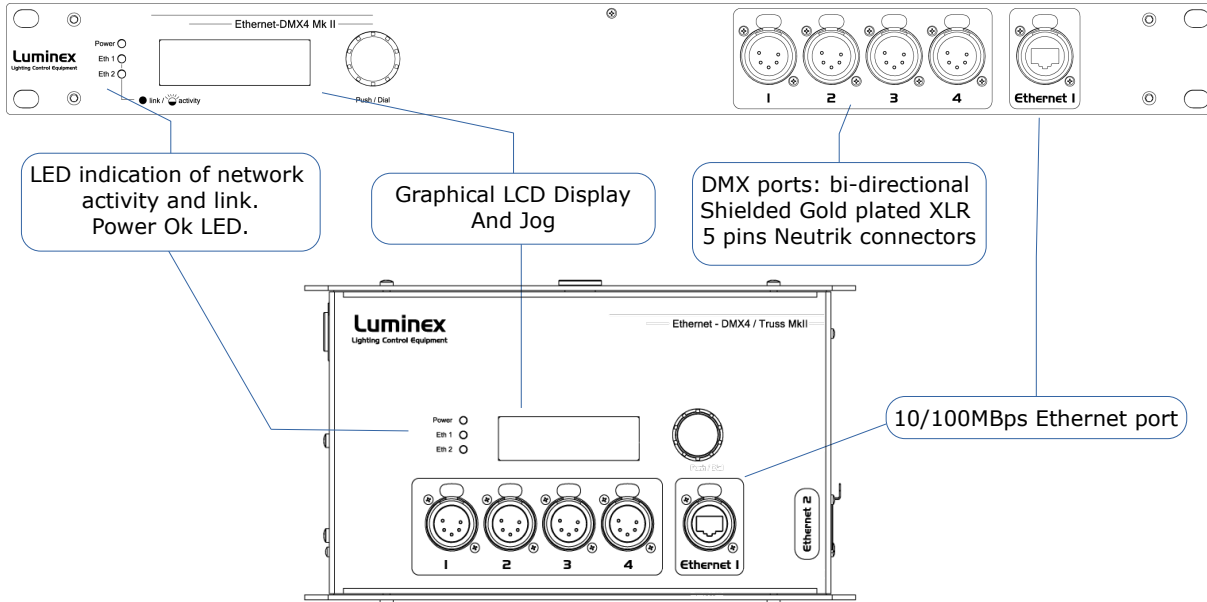

The front panel interface is provided with 1 graphical LCD display, 1 jog, 1 Ethernet port, 4 DMX outlets and 3 indication LEDs. Standard DMX port routing and advanced features like merging, backup, etc can be configured from the built in Web interface .

- **Ethernet port**

1 Neutrik RJ45 Ethercon is provided as Ethernet link.

- **DMX input / output**

4 shielded Neutrik 5 pin gold plated female connectors are provided as outlet (input or output). All DMX outlets are optic and galvanic isolated.

<b>Connector</b>	<b>Function</b>
Pin 1	Signal common (0 volt)
Pin 2	Data complement (-)
Pin 3	Data true (+)
Pin 4	Not used
Pin 5	Not used

All outlets are compliant with the DMX512-A timing specification and are terminated and rebiased.

### **Status indication**

3 LEDs are provided to indicate Network link and activity (Ethernet ports 1&2), and power Ok.

- **Front end display information**

Three indication screens will rotate continuously on the display with an interval of a few seconds.

**Screen 1 – Model and firmware version**

```
Ethernet-DMX4/Truss MkII
ID:001
Firmware Ver:4.0.5
```

This screen informs you on the type of model of Ethernet-DMX4 you're using. It gives also the ID number, and the firmware the node is actually running.

**Screen 2 – Network settings**

```
1:Node FOH
IP: 2.193.145.1
Netmask: 255.0.0.0
```

This screen displays the short name entered through the Web interface. It gives also the complete network setting information, such as IP address and netmask.

**Screen 3 – Model and firmware version**

```
Port:      1 2 3 4
Dir:       0 0 I I
Mode:      N H N N
```

This screen gives a complete overview of the DMX ports settings: the second raw gives information on the direction set on each port. The third raw informs you on the mode set on each outlet.

Regarding the direction, different letters will appear to show the mode set on the outlet : N (Normal), H (HTP merge), L (LTP merge), C (Custom), B (Backup).

See page 15 for the explanation of each available mode.

- **Unlock the node**

When the node is password protected through the Web interface, it will automatically lock the access to the Web interface. To unlock the node, enter the password in the password field (login = admin).

- **Reset the node (Out of jail)**

This useful function makes it possible to bring the node in a factory default.

1. Press and hold the jog on the front panel
2. Power up the device
3. wait until the converter to display the reset confirmation
4. confirm
5. The unit is now rebooting to its default settings

# Web interface

## Status

The complete device can be configured from an intuitive Web interface. You just have to browse to the IP address of the unit. If you do not know the IP address, you can quickly discover it through the front end display or by running Luminet Monitor V2 software (free downloadable tool), which shows all Luminex nodes on the network.

Make sure that the computer, you use to browse, is setup in the correct network address range (IP 2.x.x.x or 10.x.x.x and subnet 255.0.0.0).

When you're not using a complete network setup (Ethernet switches, hubs, routers, WLAN, ...), you can also use either a cross Ethernet cable or straight Ethernet cable to directly connect to unit to your computer.

After all connections and setup on the computer are completed, open your favorite web browser (we recommend Firefox) and enter the IP address you want to reach in the URL field : [Http://2.x.x.x](http://2.x.x.x)

**Luminex** Lighting Control Equipment

English

**Status**

Active Profile: None

**DMX Routing**

	Direction	Protocol	Universe	Mode	IP Merge	Legend	Unicast	RDM	Info
Outlet 1:	output	ArtNet	001 (0x01)	normal	disabled	Outlet 1	NA		
Outlet 2:	output	ArtNet	002 (0x02)	normal	disabled	Outlet 2	NA		
Outlet 3:	output	sACN	00001	normal	disabled	Outlet 3	NA		
Outlet 4:	output	sACN	00002	normal	disabled	Outlet 4	NA		

**Global Settings**

ID No: 001  
Trigger universe: Disabled  
DMX details:  
→ framerate: 36 Fps  
→ break: 184 µS  
→ Continuously

**Network Settings**

Node	
IP:	2.193.145.18
Netmask:	255.0.0.0
Port:	0x1936
MAC:	00:50:C2:9C:91:12
Short name:	Ethernet-DMX4MkII
Long name:	Ethernet-DMX4 MkII Rack Version

You'll end up at the status page of the device. This page has a complete overview of the device settings.

The overview shows the actual DMX and network setting / routing of the complete device.

The Web interface offers several languages. Select the language that fits your needs in the drop down menu located on the top right side of the Web page.

## Setup

Choose one of the items in the sub menu to setup the device.

Once in a setup page, help is available on almost every field title. Just click on the question mark next to the topic. A pop up frame will display the overall information of each term displayed on the Web interface.

- **Node**

To setup the node click on the appropriate sub menu item in the Setup navigation bar (Node).

**Set Up:: Node 1 (Outlet 1 - 4)**

**DMX Routing**

Message:

	Direction [?] Input/output:	Protocol [?] ArtNet/sACN	Universe [?] -1/-1 -1/14 -15/16	Mode [?] disabled/normal	IP Merging [?]	Legend [?]	Unicast [?]	RDM [?]
1	Output	ArtNet	1 (1)	Normal	Disabled	Outlet 1		<input type="checkbox"/>
2	Output	ArtNet	2 (2)	Normal	Disabled	Outlet 2		<input type="checkbox"/>
3	Input	sACN	1:100	Normal	Disabled	Outlet 3	239.255.0.1	<input type="checkbox"/>
4	Output	sACN	2	Normal	Disabled	Outlet 4		<input type="checkbox"/>

Submit Changes Reset

**Network Settings**

**IP Settings**

ArtNet compliant?  [?]

Auto ArtNet:  [?]

IP: 2.193.145.18 [?]

Netmask: 255.0.0.0 [?]

Broadcast: 255.0.0.255 [?]

Port (Hex): 1936 [?]

**Node Identification**

Short name: Ethernet-DMX4MkII [?]

Long name: Ethernet-DMX4 MkII Rack Version [?]

Submit Changes Reset

This is the main settings page. You can setup every single outlet of the node, as input or output. Select the outlet's direction, mode, protocol and universe, enable/disable RDM traffic. Here you can also change the IP address, Netmask, port and the Art-Net™ short and long name indication.

- **DMX Routing**

To better understand the use of all features, let's define each category of this menu:

**Direction** : Set the direction you need to the outlet, either Input or Output. Depending your selection, some features won't be available in the other categories.

**Protocol** : Determines the network protocol used for the outlet (Art-Net™ or streaming over ACN (sACN E1.31))

**Universe** :

*ArtNet*: Select one of 256 possible universes available in the Art-Net™ protocol. This is used for addressing DMX lines on Art-Net™. The hexadecimal value of the universe is in between brackets. The first digit equals to the Art-Net™ subnet and the second to the Art-Net™ universe within that subnet.

*sACN* : Select the sACN universe to use for addressing DMX lines on sACN. You can enter a numeric value between 1 and 63999. In case of an input, the priority of the universe can be set by adding a colon and the priority value. The priority level can go from 0 to 200. A higher level has a higher priority. (ex: 678:100 means universe 678 at priority level 100)

**Mode** : According to the direction you set on the outlet, this menu offers several mode :

Input :        Disabled : Outlet is disabled, better for node performance.  
                  Normal : Outlet set as normal input  
                  Merge : Allow to merge 2 DMX streams.

When outlet 1 is configured as a merged input, the next outlet (2) will be automatically set as input as well.

Output :        Disabled : Outlet is disabled, better for node performance.  
                  Zero : Send all channels with a zero value (for maintenance only)  
                  Normal: Normal output.

**IP Merging** : This special feature allows you to merge up to 4 different Art-Net™ or sACN streams through the network. The merging policy will be mainly applied on the Output, except for IP backup.

**Legend** : Set a legend to the outlet, useful to remind yourself what's connected to that outlet.

**Unicast** : Art-Net™ is a broadcast protocol, which means that each packet sent from a single source will be received by all active equipment on the network. Unicast provides you to cast your data to a selected IP address, resulting in a lower use of bandwidth.

**RDM** : Enable / disable RDM. Enabling RDM allows RDM traffic to be transported from/to outlet over the network and back. The nodes will act as an unmanaged proxy device. When set as output it is also possible to enable Adaptive Discovery (AD). AD will continuously check for new and disappeared RDM devices on the output.

Once RDM is activated, you'll notice a cross in the status page. Click on this cross to see the list of discovered RDM devices (Illustration 1) attached to the node.

**Status**

Active Profile: None

Outlet	Direction	Protocol	Universe	Mode	IP Merge	Legend	Unicast	RDM	Info
Outlet 1:	output	ArtNet	001 (0x01)	normal	disabled	Outlet 1	NA	X	
Outlet 2:	output	ArtNet	002 (0x02)	normal	disabled	Outlet 2	NA		
Outlet 3:	input	sACN	00001:100	normal	disabled	Outlet 3	239.255.0.1		
Outlet 4:	output	sACN	00002	normal	disabled	Outlet 4	NA		

**Global Settings**

ID No: 001  
 Trigger universe: Disabled  
 DMX details:  
 → framerate: 36 Fps  
 → break: 124 µS  
 → Continuously

**Network Settings**

Node	
IP:	2.193.145.18
Netmask:	255.0.0.0
Port:	0x1936
MAC:	00:50:C2:9C:91:12
Short name:	Ethernet-DMX4MkII
Long name:	Ethernet-DMX4 MkII Rack Version

Access to the RDM discovered devices

**Uid**

44:45 - 04:D5:AF:B7

45:4E - 02:05:65:05

© 2010 Luminex LCE

*Illustration 1: Discovered RDM devices*

All setting that are not applicable for the actual setting will be grayed out or marked as N/A (Not Applicable).

- **Merging Policies :**

The Ethernet-DMX4 MkII firmware offers enhanced merging policies that fits to all kind of setup, even the most complex one !

4 available merging policies can be applied on your DMX network, in 2 main setup categories :

Local merging : 2 different DMX streams are merged on the same physical device (Node). The merging policy will be mainly set on Inputs.

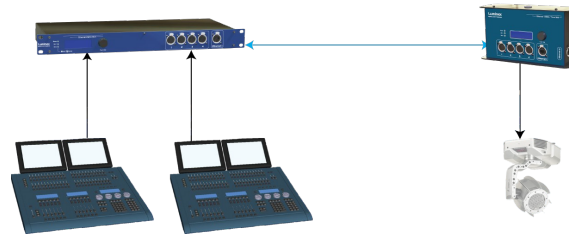

*Illustration 2: Local DMX merging*

IP Merging : This special feature allows you to merge up to 4 different Art-Net™ or sACN streams through the network. The merging policy will be mainly applied on the Output, except for IP backup.

Available policies :

- HTP : Highest Take Precedence; Commonly used to merge dimmer channels. Up to 4 Art-Net™ or sACN sources can be merged.
- LTP : Latest Take Precedence; Better suited when using moving lights. Up to 4 Art-Net™ sources can be merged.
- Backup : Can be used either on input or output. When used on input, this policy allows you to add a backup DMX console on the second input. When used on a custom output, the policy allows you to add a backup Art-Net™ or sACN source on the network.
- Custom : This is the most complete and efficient policy. This mode offers you to choose what policy to apply for each channel of each universe, and also to create a complete custom soft patch. By more, the merging policy can be remotely controlled triggered by DMX. Up to 2 Art-Net™ or sACN sources can merged thanks to that policy.

The available policies differs if you use either inputs or outputs :



### Inputs (Local mode)

	<b>Direction</b>	<b>Protocol</b>	<b>Universe</b>	<b>Mode</b>
Outlet 1	Input	ArtNet or sACN	1(01)	Merge
Outlet 2	Input		Ch1	HTP, LTP, Backup, Custom
Outlet 3	Input		2(02)	Disabled
Outlet 4	Input		3(03)	Disabled

In this example (left node of Illustration 2), the selected mode is “**Merge**”. The second outlet will automatically be set as a merged input. You will not be able to configure a universe address for the second outlet, as the merged result will end at the universe address of the first outlet (primary input). Instead of universe you will be able to set the starting DMX channel address (1-512). This indicates from which channel address the second input has to be merged in. This offset is only available when using **HTP** or **LTP** policies. Those rules will be applied on all channel of the whole universe.

If you choose “**Backup**”, a small blue icon will appear on the left side of “Outlet 2” label; then click on it, a pop up frame appears :



Illustration 3: DMX Input backup merging

This menu lets you choose the backup time (from 400 to 9999ms). This time represents the delay from which the node will automatically switch to the backup outlet when invalid or no DMX is received anymore on the primary outlet.

Tick the box if you want the node to auto-recover as soon as valid data is available again on primary connector.

If you tick off the box, you will have to enable the trigger universe and select a recover channel (page 26).

If you choose “**Custom**” policy, a small blue icon will also appear on the left side of “Outlet 2” label; then click on it, a new pop up frame appears :

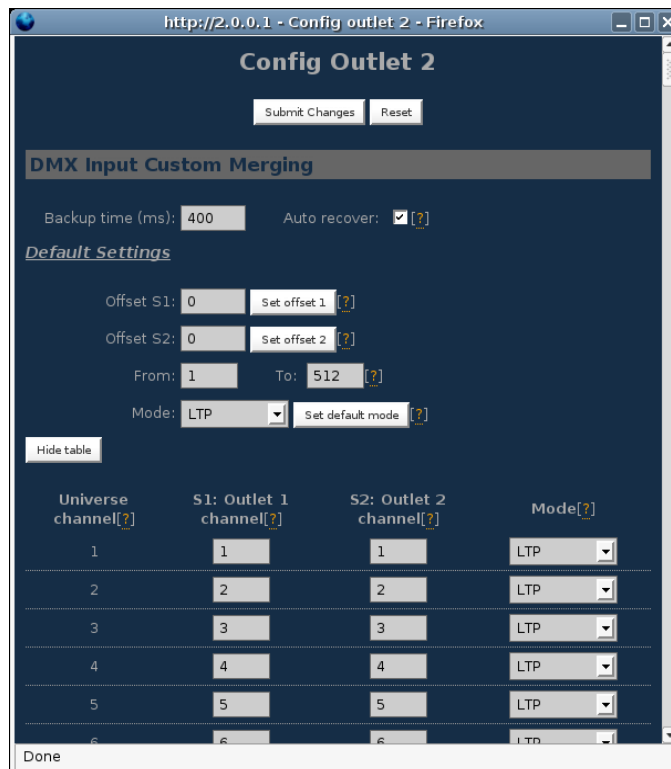

Illustration 4: Custom DMX input merging

Click on “**Show Table**” button to see the complete soft patch available for this outlet.

- **Offset S1 & S2** : Enter a value for the desired offset of the starting channel for outlets 1 or 2; example, for channels 1 to start on the third channel, enter 3.
- **From – To** : this range let you quickly set the policy you need on the channel range of your choice. example, if you need HTP policy on channels 23 to 145, enter 23 in the “**From**” field and “145” in the “**To**” field. Then select the HTP policy in the “**Mode**” drop down list, then press “**Set Default Mode**”.

Notice that following policies are available for each channel:

Zero, HTP, LTP, S1 only (Source 1 only), S2 only (Source 2 only); S1 as Backup (Source 1 as backup), S2 as Backup (Source 2 as Backup).

The left column represent the resulting universe channel number streamed to the network. S1 column represents Source 1 channels and S2 column source 2 channels. It's thus easy to understand that you can create your own soft patch by entering the channels of your choice in one of theses column.

Once your patch is created, click submit to close the window, then click submit again on the node page to record your settings.

### Inputs (IP Merging)

	<b>Direction</b>	<b>Protocol</b>	<b>Universe</b>	<b>Mode</b>	<b>IP Merging</b>
Outlet 1	Output	Artnet or sACN	1(01)	Normal	Disabled
Outlet 2	Input	Artnet or sACN	1(01)	Normal	Backup
Outlet 3	Input		2(02)	Disabled	Disabled
Outlet 3	Input		3(03)	Disabled	Disabled

This mode can be very useful in such an application.

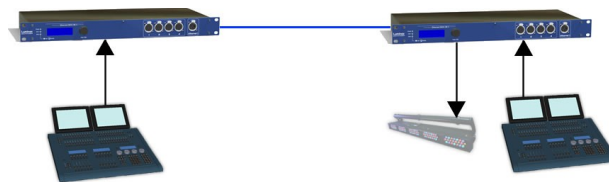

Illustration 5: IP Merging

The right side lighting desk is used as a backup desk on stage. This means that the right side node will automatically switch to that outlet if no Art-Net™ or sACN packets are available on the selected universe (in that case universe 0). Select your backup time in the small pop up frame by clicking the left blue icon, then submit your changes.

### Outputs (IP Merging)

	<b>Direction</b>	<b>Protocol</b>	<b>Universe</b>	<b>Mode</b>	<b>IP Merging</b>
Outlet 1	Output	Artnet or sACN		Normal	HTP, LTP, Custom
Outlet 2	Input		1(01)	Disabled	Disabled
Outlet 3	Input		2(02)	Disabled	Disabled
Outlet 4	Input		3(03)	Disabled	Disabled

This mode can be very useful in the case of 2 control sources located in different places in the network wants to control the same DMX device in the same time.

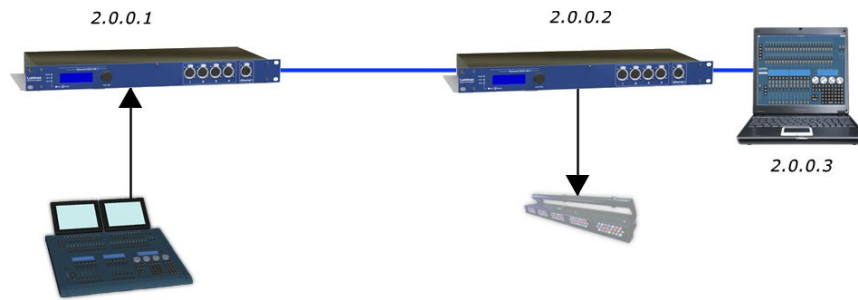

*Illustration 6: Output IP merging*

In this setup, the right lighting software (S2) is used in the same time as the left lighting desk (S1). Both streams are merged through the final output on the right node.

The IP Merging mode provides the following policies when an outlet is set as output:

- HTP, for all outlet channels. Up to 4 Art-Net™ or sACN sources can be merged.
- LTP, for all outlet channels. Up to 4 Art-Net™ sources can be merged.
- Custom, to create a complete soft patch, to set merging policy for every single channel by IP source and protocol, and to use the enhanced trigger system. Two Art-Net™ or sACN sources can be merged.

If you choose "Custom", click on the blue icon left sided to the "Outlet" label. A pop up frame appears:

**Config Outlet 1**

Submit Changes Reset

**DMX Output Custom IP Merging**

**IP/Universe Settings**

IP source 1: 2.0.0.1 Universe: 1 SACN [?]

IP source 2: 2.0.0.3 Universe: 2 (02) ArtNet [?]

Backup time (ms): 400 Auto recover: [?]

**Default Settings**

Offset S1: 2 Set offset 1 [?]

Offset S2: 0 Set offset 2 [?]

From: 1 To: 2 [?]

Mode: S2 Only Set default mode [?]

Trigger Chn: 501 Set default trigger [?]

Hide table Export patch

Output channel[?]	Source 1 channel[?]	Source 2 channel[?]	Mode[?]	Trigger[?]
1	-	1	S2 Only [?]	501
2	-	2	S2 Only [?]	501
3	1	3	LTP [?]	500
4	2	4	LTP [?]	500
5	3	5	LTP [?]	500
6	4	6	LTP [?]	500
7	5	7	LTP [?]	500
8	6	8	LTP [?]	500
9	7	9	LTP [?]	500
10	8	10	LTP [?]	500

Illustration 7: DMX Output custom IP merging

You can find in this pop up frame similar features as when using the custom merging on outlets set as inputs (page 18).

The main difference is about the following points :

- **IP Source 1 & 2** : Here you can enter the 2 IP addresses assigned to your 2 control source. In case you don't know one of your source IP address, simply enter 0.0.0.0 in the address field.
- **Universe** : Here you can select the universes number and the protocol streamed by your control sources. This feature is very useful if the 2 sources don't use the same universe number or protocol.
- **Trigger channel**. This feature allows you to remotely change the merging policy of one or several dedicated channels through a single DMX value. From anywhere on the network, you can by example swap from a "LTP" merge to a "S2 only" policy simply by using a different DMX trigger channel value. Enter here the DMX channel you want to use to remotely takeover control of the merging rule. Once you've selected that channel, you'll need to reach the "Global" web page of the node to enable and select your Trigger universe. You'll also need to patch or assign a DMX trigger channel to your control source; here is the DMX chart of the Luminex DMX trigger channel :

0 - 7	Do nothing
8 - 15	Zero out
16 - 23	HTP merge
24 - 31	LTP merge
32 - 39	Source 1 only
40 - 47	Source 2 only
48 - 111	Reserved
112 - 119	Source 1 as backup
120 - 127	Source 2 as backup
128 - 255	Do nothing

**Note** :Never forget if you control the trigger channel from more than one source to press "Do nothing" once you've selected the desired value. Indeed, if you send 2 different values from 2 different sources for the trigger channel, the node won't stop swapping between those values, what results in a big slowing down of the node processing power.

### ***Recover channel***

If you have set one of a node outlet in IP backup mode, the node will swap automatically to this outlet in case of DMX failure from the primary source. Once the primary source is back again available, the node will automatically swap back to that source if set in Auto-recover mode. We all know that it can be useful to decide when to swap back to the primary source (booting time of the desk + loading the right cue in case of desk failure). Tick off the auto-recover box in the pop up window if you decide to work in manual recover mode. Then you'll have to enable the trigger universe in the "Global" Web page and choose a recover channel. You now have the opportunity to choose to recover either each outlet one by one or all outlet in one shot.

Here is the Luminex recover channel DMX chart :

Value	Outputs	Merged Input pairs	Normal Inputs
0 – 7	Do nothing	Do Nothing	Do Nothing
8 – 15	Recover Outlet 1	Recover IP backup	Recover IP backup
16 – 23	Recover Outlet 2	Recover DMX Backup	Recover IP backup
24 – 31	Recover Outlet 3	Recover IP backup	Recover IP backup
32 – 39	Recover Outlet 4	Recover DMX Backup	Recover IP backup
40 – 47	Recover Outlet 5	Recover IP backup	Recover IP backup
48 – 55	Recover Outlet 6	Recover DMX Backup	Recover IP backup
56 – 63	Recover Outlet 7	Recover IP backup	Recover IP backup
64 – 71	Recover Outlet 8	Recover DMX Backup	Recover IP backup
72 – 79	Recover all outlets	Recover All Backup	Recover all backup
80 – 255	Do Nothing	Do Nothing	Do Nothing

All those soft patches can be recorded or loaded from or to the node by using "Load Patch" or "Export patch" buttons. Luminex node recognize .txt files. These are "TAB" separated files which can be edited using spreadsheet software (Excel, OO Calc,...)

## Network settings

**Network Settings**

**IP Settings**

ArtNet compliant?  [?]

Auto ArtNet:  [?]

IP:  [?]

Netmask:  [?]

Broadcast:  [?]

Port (Hex):  [?]

**Node Identification**

Short name:  [?]

Long name:  [?]

### IP Settings

You can enter here the desired Art-Net™ IP address and Netmask you want to use. If you're not confident with Art-Net™ IP setting, tick the "Art-Net™ compliant?" box for the node to warn you in case of mistake. Art-Net™ IP addresses usually look like 2.x.x.x or 10.x.x.x.

You're not obliged to work with Art-Net™ IP addresses. If you wish to work with usual IT IP addresses as 192.168.x.x, there's no problem for you to set such address on the node. Please remember that your node will thus not be visible on the network from devices set with conventional Art-Net™ IP addresses (2.x.x.x or 10.x.x.x).

The Port field allows you to change the UDP port used on the network to transmit your UDP Art-Net™ packets. Luminex recommends not to change this value.

### Node identification :

Enter here a small and long name to easily identify your node on the network through a Web interface, Art-Net™ compliant softwares or Luminex LumiNet monitor.



- **Global**

Some global settings can be altered by clicking Global in the Setup sub menu. Device Settings

**Set Up:: Global Settings**

**Device Settings**

ID No.: 001 [?]  
Enable trigger:  Universe: 0 (00) [?]  
Recover channel: - [?]

**DMX Details**

DMX framerate: 36 Fps [?]  
Break: 184 μS [?]  
DMX output time: Continuously [?]

**Miscellaneous**

Verbose level: Show warnings + errors [?]  
Lock mode: No lock [?]  
Locking code: \*\*\*\* [?]  
Confirm code: \*\*\*\* [?]  
Backlight auto off:  [?]

Submit Changes Reset

Here you can change the device's ID number which is indicated on LumiNet monitor.

You can also enable the Trigger universe to remotely control your merging policy through any DMX source. The node will listen to the specified universe entered in the universe field.

You can set your Recover channel if you use the manual recovery mode (page 18, 23).

**DMX details**

The DMX frame rate setting for all outlets. This can be set from 20 to 40 frames per second. Break Time can be set from 176 to 352μs.

DMX Output time can be set to 1 – 10 minutes or continuously. This time sets how long an output remains outputting it's last DMX levels after no valid DMX packet came in for that particular universe on Art-Net™ or

sACN.

## **Miscellaneous**

This part is about security and warnings :

- **Verbose level** : Select if you want to see error and warning messages on the front end LCD or through the Web interface.
- **Lock Mode**: select the security level you want to be applied on your Ethernet-DMX4 MkII front end. Auto lock will force the Node to lock the jog after 2 minutes of front end inactivity.

Password protected mode will guide you to set a password into the "locking code" field. Once the node is locked, you'll have to enter the 4 digit password through the Web interface password field.

## Toolbox

When clicking on Tools in the navigation bar, a sub menu appears. Choose one of the items in the sub menu.

- **Profile manager**

The profile manager is able to store 40 profiles. All profiles are stored on the device.

A preview of the complete configuration stored in a profile is shown when a profile is selected from the drop down list. When an empty profile is selected, no preview will be shown.

Once a profile is selected you can choose to recall it, to save actual settings as a profile, or to delete the profile.

The screenshot shows the 'Toolbox:: Profile Manager' interface. At the top, there is a 'Select Profile' section with a dropdown menu showing '03: Out 0-3 HTP'. Below the dropdown are five buttons: 'Recall Profile', 'Save Profile', 'Delete Profile', 'Export Profile', and 'Import Profile'. A callout box points to the 'Export Profile' button, containing the text: 'Export profile Download link to save selected profile'. Below this is a 'Profile PREVIEW (3: Out 0-3 HTP)' section. Under the heading 'DMX Routing', there is a table with the following data:

	Direction	Protocol	Universe	Mode	IP Merge	Legend	Unicast	RDM	Info
Outlet 1:	output	ArtNet	000 (0x00)	normal	HTP	Output 1	NA		
Outlet 2:	output	ArtNet	001 (0x01)	normal	HTP	Output 2	NA		
Outlet 3:	output	ArtNet	002 (0x02)	normal	HTP	Output 3	NA		
Outlet 4:	output	ArtNet	003 (0x03)	normal	HTP	Output 4	NA		

Below the table is the 'Global Settings' section, which includes: 'ID No: 001', 'Trigger universe: Disabled', and 'DMX details:' with sub-items: 'framerate: 36 Fps', 'break: 176 µS', and 'Continuously'.

When recalling a profile, an other page will appear to ask whether to recall your network settings as well or only the outlet routings.

When saving a profile a next page will ask you to fill in a profile name.

## Snapshot manager

The Ethernet-DMX4 MkII embeds a snapshot function that allows you to capture 3 lighting states (fixed values) per outlet. The snapshot function is only available for outlets set as single outputs.

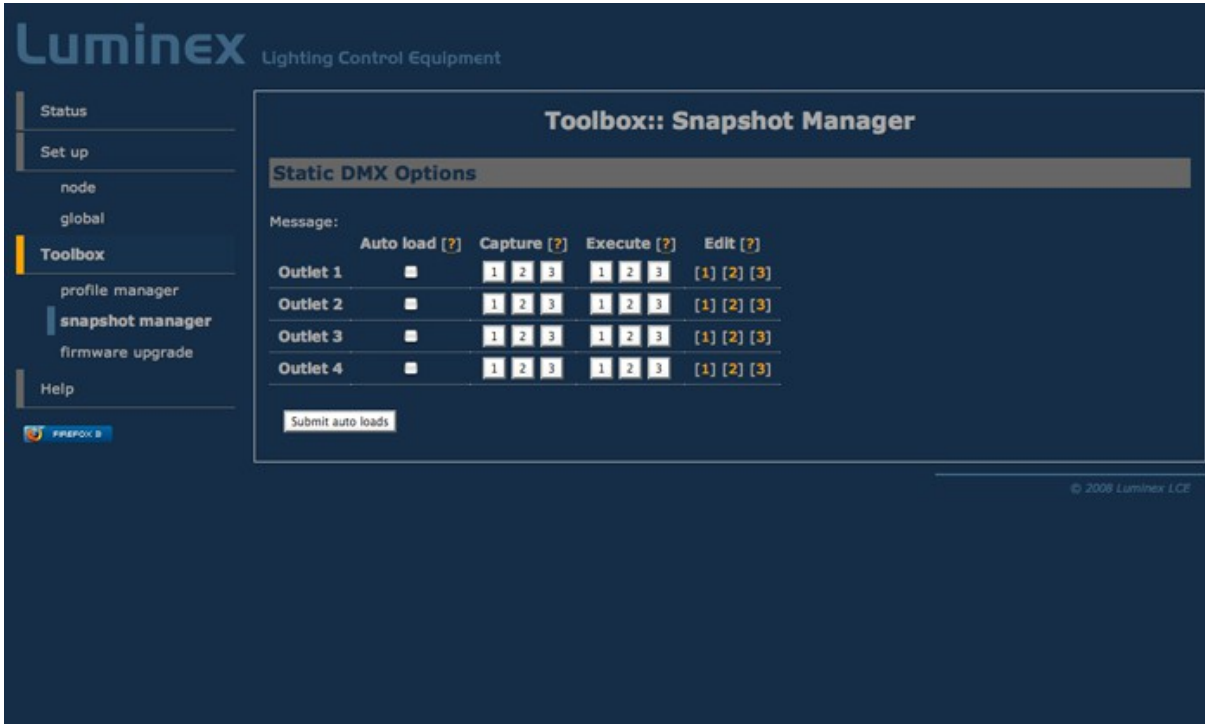

**Auto load** : When this option is ticked and the outlet is set as a single output, then the unit will automatically load snapshot 1 at startup of the node. As soon as Art-Net™ or sACN data arrives for that output, the DMX output will change. This feature is ideal for use in exhibition or expos.

**Capture** : Captures actual output state as a static DMX snapshot when there is DMX running on the output. Simply press on one of the 3 captures available to snapshot the DMX output.

**Execute** : Executes clicked snapshot and sets it on the DMX output when configured as a single output. The execute can't work if the associated universes runs on the network.

**Edit** : Link to edit captured snapshot in a channel table (see following screenshot). Here you can directly edit and change channel values. You can also directly create your lighting state from that windows by inserting desired values, and recall the snapshot from the Web interface.

Toolbox :: Edit Outlet 1 Snapshot 1										
Static DMX Values For Outlet 1 Snapshot 1										
Channel	1	2	3	4	5	6	7	8	9	10
0	0	0	0	0	0	0	0	0	0	0
10	0	0	0	0	0	0	0	0	0	0
20	0	0	0	0	0	0	0	0	0	0
30	0	0	0	0	0	0	0	0	0	0
40	0	0	0	0	0	0	0	0	0	0
50	0	0	0	0	0	0	0	0	0	0
60	0	0	0	0	0	0	0	0	0	0
70	0	0	0	0	0	0	0	0	0	0
80	0	0	0	0	0	0	0	0	0	0
90	0	0	0	0	0	0	0	0	0	0
100	0	0	0	0	0	0	0	0	0	0
110	0	0	0	0	0	0	0	0	0	0
120	0	0	0	0	0	0	0	0	0	0
130	0	0	0	0	0	0	0	0	0	0
140	0	0	0	0	0	0	0	0	0	0
150	0	0	0	0	0	0	0	0	0	0
160	0	0	0	0	0	0	0	0	0	0
170	0	0	0	0	0	0	0	0	0	0

### Capture recall

The Ethernet-DMX4 MkII offers a user friendly interface for users to easily recall the recorded snapshots from the Web interface. Type the following address to reach the execute buttons page, where w.x.y.z represents the Ethernet-DMX4 MkII IP address : [http://w.x.y.z/cgi-bin/toolbox\\_outlet.cgi/](http://w.x.y.z/cgi-bin/toolbox_outlet.cgi/)

For instance:

[http://2.192.144.1/cgi-bin/toolbox\\_outlet.cgi/](http://2.192.144.1/cgi-bin/toolbox_outlet.cgi/)

### Toolbox:: Snapshot Manager

---

#### Static DMX Options

Message:

Execute ?

Outlet 1 1 2 3

Outlet 2 1 2 3

Outlet 3 1 2 3

Outlet 4 1 2 3

© 2008 Luminex LCE

- **Firmware upgrade**

The firmware upgrade page allows you to select a downloaded firmware file and upload it to the device.

This page shows the actual firmware version running on the unit below the file upload field.

The latest firmware file can always be downloaded from the Luminex web pages.

[Http://www.luminex.be](http://www.luminex.be)

To install the firmware on the Ethernet-DMX4 MkII follow these steps:

1. Download the .zip file and save it on your hard disk.
2. Extract the .zip file.
3. Please read the "ChangeNote.txt" for latest release changes.
4. Browse to the device its IP address with your favorite web browser.
5. Click Toolbox -> Firmware upgrade.

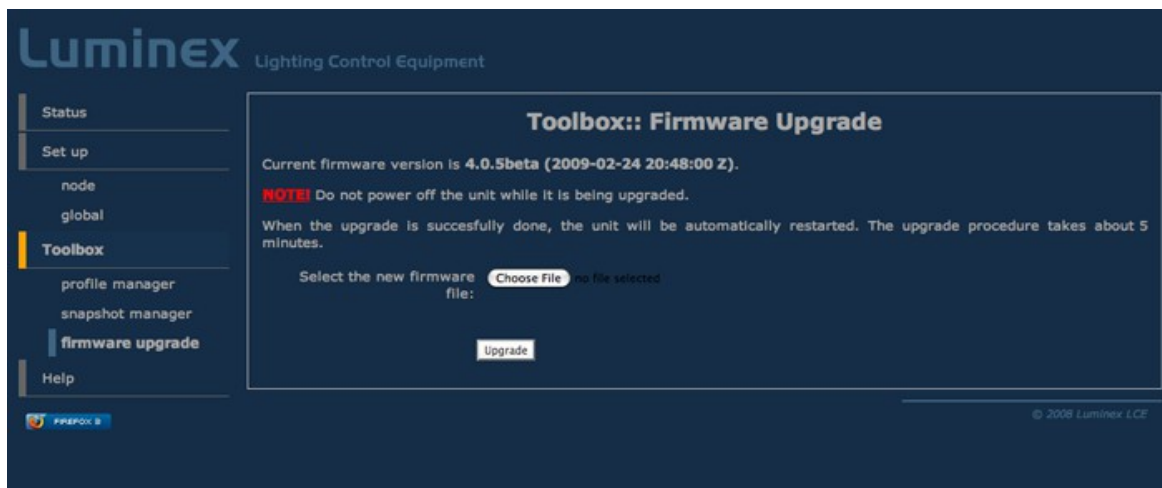

6. Browse to the extracted upgrade file on your hard disk (ethdmx4(truss)mkii\_v4.X.X.bin), where X.X represents firmware version.
7. Select the file and press on the "Upgrade" button.
8. The upgrade file will be sent to the device. The following message appears on the front end display:

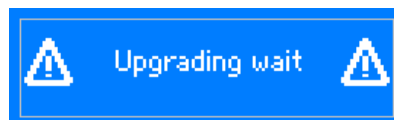

9. The unit will then reboot after the upgrade procedure and will display the following message on front end display:

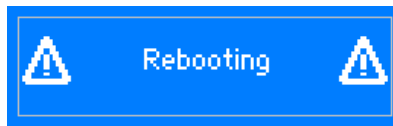

10. Wait until the device has rebooted. (until then the Power/Ok LED will be blinking). A solid Power/Ok LED on indicates your Ethernet-DMX4 MkII has been properly updated.
11. Click now on Toolbox -> Firmware upgrade if the current version is set to the right version number. If the number is the same as mentioned with the file then the upgrade succeeded.



## Toubleshooting

- The Power/OK LED is always blinking:

You're Ethernet-DMX4 MkII doesn't boot properly. Restart the unit with the power switch. If this doesn't help, contact your local dealer. Please note the Power/OK LED will be blinking during upgrade procedure, don't switch off the power during this step.

- My computer is connected to the node, but the Link/Activity LED is still off.

Check the Ethernet cable you're using, and check that each RJ45 on each side of the cable is properly inserted. Feel free to plug another cable to isolate the problem.

- I can't reach the Web interface of the Ethernet-DMX4 MkII

Please check first the two previous steps. Then please be sure your computer is set in the same IP range than your Ethernet-DMX4 MkII. Try to ping the unit with a dedicated application, such as a DOS session on Windows, or a terminal session on MAC. You can use LumiNet Monitor V2 to discover your Ethernet-DMX4 MkII. If you can't see your device in LumiNet Monitor V2, please contact your local dealer.

## Additional Documentation

All additional documentation can be downloaded from our web pages in the support section.

[Http://www.luminex.be](http://www.luminex.be)

--> Support

### ***Credits:***

**Art-Net™ Designed by and Copyright Artistic Licence Holdings Ltd**