

# MTX48/88

## User Manual



[www.audac.eu](http://www.audac.eu)



# Index

|  |           |
|--|-----------|
| <b>Introduction</b>  | <b>5</b>  |
| <b>MTX Block Diagram</b>                                   | <b>6</b>  |
| <b>Precautions</b>   | <b>7</b>  |
| <b>Safety requirements</b>                                 | <b>7</b>  |
| <b>Caution servicing</b>                                   | <b>7</b>  |
| <b>CE Declaration of Conformity</b>                        | <b>7</b>  |
| <b>Waste of Electrical and Electronic Equipment (WEEE)</b> | <b>8</b>  |
| <b>Caution</b>   | <b>8</b>  |
| <b>Additional information</b>                              | <b>8</b>  |
| <b>Chapter 1: Pin connections and connectors</b>           | <b>9</b>  |
| <b>Connection standards</b>                                | <b>9</b>  |
| <b>Wire up the system</b>                                  | <b>11</b> |
| <b>Chapter 2: Front &amp; rear panel</b>                   | <b>12</b> |
| <b>Front panel overview</b>                                | <b>12</b> |
| <b>Front panel functions</b>                               | <b>13</b> |
| <b>Functions overview</b>                                  | <b>15</b> |
| <b>Rear panel overview</b>                                 | <b>17</b> |
| <b>Chapter 3: MTX Quick start guide</b>                    | <b>20</b> |
| <b>Connecting the MTX</b>                                  | <b>20</b> |
| <b>Configuring the MTX</b>                                 | <b>21</b> |
| <b>Chapter 4: User interface &amp; configuration</b>       | <b>23</b> |
| <b>Open the user interface</b>                             | <b>23</b> |
| <b>Login screen</b>  | <b>23</b> |
| <b>Main screen</b>   | <b>24</b> |
| <b>Zone settings</b>                                       | <b>25</b> |
| <b>Input selection</b>                                     | <b>27</b> |
| <b>Configuration settings screen</b>                       | <b>28</b> |
| <b>Paging volume</b>                                       | <b>29</b> |
| <b>Priority settings</b>                                   | <b>29</b> |
| <b>System configuration</b>                                | <b>31</b> |
| <b>Mono / Stereo</b>                                       | <b>32</b> |
| <b>Network settings</b>                                    | <b>33</b> |
| <b>Password settings</b>                                   | <b>33</b> |
| <b>Factory settings reset</b>                              | <b>34</b> |

|  |           |
|--|-----------|
| <b>Chapter 5: Peripheral interfaces</b>  | <b>35</b> |
| Peripheral equipment combinations        | 36        |
| Wall mounted control panels              | 38        |
| MWX43/45 Basic wall panel                | 38        |
| MWX65 All-in-one wall panel              | 40        |
| WMI and WLI Wall Input units             | 41        |
| MTX Wall Panel Connection possibilities  | 42        |
| Paging                                   | 44        |
| Peripheral connection limits             | 47        |
| <br>                                     |           |
| <b>Chapter 6: Additional information</b> | <b>48</b> |
| IP Basics                                | 48        |
| Updating the MTX                         | 49        |
| Technical specifications                 | 50        |
| Personal notes                           | 51        |

# Introduction

## Multi–Zone Matrix

The MTX is AUDAC's series of very cost efficient audio matrix systems for a wide range of Multi–Zone audio applications, offering two different models with the same features and possibilities, but with different zone capacities.

The MTX88 is the eight–zone version, and the MTX48 is the four–zone version.

Both containing two balanced microphone inputs with priority and phantom power possibility and three–band tone control.

Four stereo line–level inputs are provided to which any line–level music source such as a CD–player, Tuner or MP3 player, ... can be connected. The other two inputs of the matrix are the additional wall panel inputs for both line and microphone signals.

What makes the MTX system superior to all other matrix systems in their range, are the advanced control possibilities. The MTX can be controlled by means of additional control panels for every specific zone, with or without additional audio inputs. It also features a fully functional web based interface that can be used to control and configure the audio system with any device connected in your LAN network by just using a standard web browser.

The MTX is also compatible with the Audac touch app for smart devices. The RS232 port makes it possible to control it by means of any external equipment such as home & industrial automation systems supporting RS232.

The front panel of the MTX contains for every zone a rotary push button with indication LED's whereby all the controls and settings can be done. A built–in PFL loudspeaker makes it possible to pre–listen every channel without requiring headphones.

The balanced line–level zone outputs are performed using 3–pin Euro–terminal block connectors, each of them accompanied with an RJ45 connector for connecting additional wall panels to that zone.

A 24 volts power connection makes it possible to keep the MTX running on emergency power, even if the mains power is shut down.

An EXT MUTE connection allows overall system muting. This is extremely useful in case of fire–alarms or other priority systems overruling the system settings.



# MTX Block Diagram

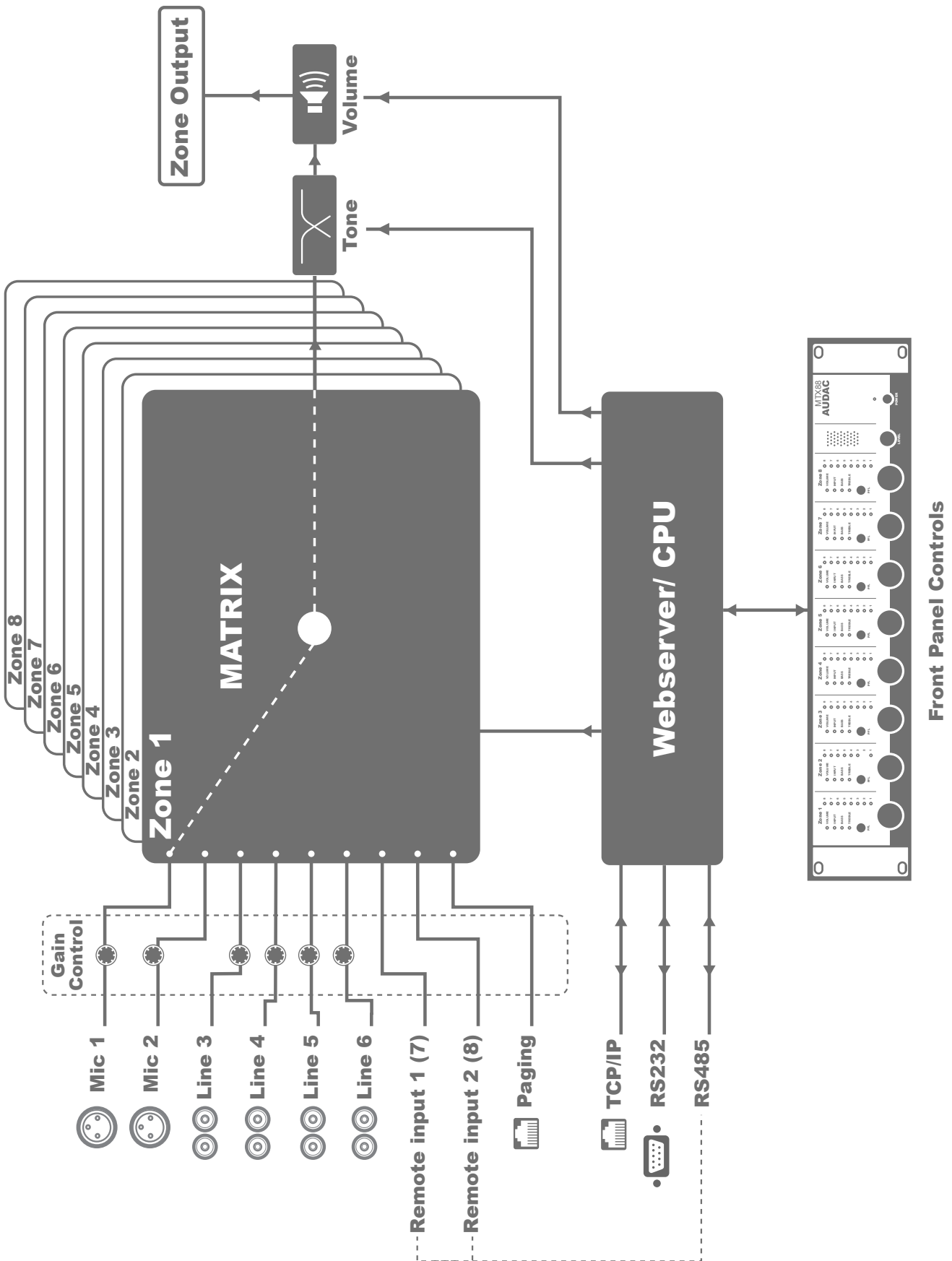

Block diagram shown for MTX88 – 8 Zone Matrix

# Precautions

## **READ FOLLOWING INSTRUCTIONS FOR YOUR OWN SAFETY**

ALWAYS KEEP THESE INSTRUCTIONS. NEVER THROW THEM AWAY

ALWAYS HANDLE THIS UNIT WITH CARE

HEED ALL WARNINGS

FOLLOW ALL INSTRUCTIONS

NEVER EXPOSE THIS EQUIPMENT TO RAIN, MOISTURE, ANY DRIPPING OR SPLASHING LIQUID. AND NEVER PLACE AN OBJECT FILLED WITH LIQUID ON TOP OF THIS DEVICE.

DO NOT INSTALL THIS UNIT NEAR ANY HEAT SOURCES SUCH AS RADIATORS OR OTHER APPARATUS THAT PRODUCE HEAT

DO NOT PLACE THIS UNIT IN ENVIRONMENTS WHICH CONTAIN HIGH LEVELS OF DUST, HEAT, MOISTURE OR VIBRATION

THIS UNIT IS DEVELOPED FOR INDOOR USE ONLY. DO NOT USE IT OUTDOORS

PLACE THE UNIT ON A STABLE BASE OR MOUNT IT IN A STABLE RACK

ONLY USE ATTACHMENTS & ACCESSORIES SPECIFIED BY THE MANUFACTURER

UNPLUG THIS APPARATUS DURING LIGHTNING STORMS OR WHEN UNUSED FOR LONG PERIODS OF TIME

ONLY CONNECT THIS UNIT TO A MAINS SOCKET OUTLET WITH PROTECTIVE EARTHING CONNECTION



### CAUTION – SERVICING

This product contains no user serviceable parts. Refer all servicing to qualified service personnel. Do not perform any servicing (unless you are qualified to)



### EC DECLARATION OF CONFORMITY

This product conforms to all the essential requirements and further relevant specifications described in following directives: 2014/30/EU (EMC) and 2014/35/EU (LVD)



### WASTE ELECTRICAL AND ELECTRONIC EQUIPMENT (WEEE)

The WEEE marking indicates that this product should not be disposed with regular household waste at the end of its life cycle. This regulation is created to prevent any possible harm to the environment or human health.

This product is developed and manufactured with high quality materials and components which can be recycled and/or reused. Please dispose this product at your local collection point or recycling centre for electrical and electronic waste. This will make sure that it will be recycled on an environmentally friendly manner, and will help to protect the environment in which we all live.

### CAUTION

The symbols shown are internationally recognized symbols that warn about potential hazards of electrical products. The lightning flash with arrow point in an equilateral triangle means that the unit contains dangerous voltages. The exclamation point in an equilateral triangle indicates that it is necessary for the user to refer to the users manual.



These symbols warn that there are no user serviceable parts inside the unit. Do not open the unit. Do not attempt to service the unit yourself. Refer all servicing to qualified personnel. Opening the chassis for any reason will void the manufacturer’s warranty. Do not get the unit wet. If liquid is spilled on the unit, shut it off immediately and take it to a dealer for service. Disconnect the unit during storms to prevent damage.

### CAUTION HOT SURFACE





## POWER SUPPLY AND POWER CORD REQUIREMENTS

### Power supply class I grounding requirements:

For protection from fault currents, the equipment shall be connected to a grounding terminal. Plug the system power cord into an AC outlet that provides a ground connection. Substitute cords may not provide adequate fault protection. Only use the power cord supplied with this product or an authorized/equivalent replacement

### Safety notices:

#### Denmark:

Apparatets stikprop skal tilsluttes en stikkontakt med jord, som giver forbindelse til stikproppens jord.

#### Finland:

Laite on liitettävä suojakoskettimilla varustettuun pistorasiaan.

#### Norway:

Apparatet må tilkoples jordet stikkontakt.

#### Sweden:

Apparaten skall anslutas till jordat uttag.

## ATTENTION

The fuse (T500mAL/250V) provides a safeguard function to the device. When replacing the fuse, make sure that the value of the replacement matches the value of the original fuse. Identification of a suitable replacement component or substitute shall be done by qualified technicians.

**ADDITIONAL INFORMATION**

This manual is put together with much care, and is as complete as could be on the publication date. However, updates on the specifications, functionality or software may have occurred since publication. To obtain the latest version of both manual and software, please visit the Audac website @ [www.audac.eu](http://www.audac.eu).

# Chapter 1

## Pin connections and connectors

### CONNECTION STANDARDS

The in- and output connections for AUDAC audio equipment are performed corresponding to international wiring standards for professional audio equipment.

#### Cinch (RCA):

For unbalanced line input connections.

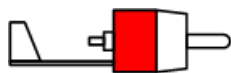

**Tip:** Signal  
**White:** Left

**Sleeve:** Ground  
**Red:** Right

#### XLR:

For balanced microphone input connections. Image shows female port (receptacle).

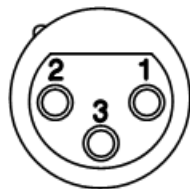

**Pin 1:** Ground  
**Pin 2:** Signal +  
**Pin 3:** Signal -

#### 3-Pin Euro-Terminal Block:

For balanced line output connections.

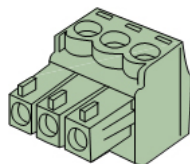

**Left:** Signal - (XLR Pin 3)  
**Center:** Signal + (XLR Pin 2)  
**Right:** Ground (XLR Pin 1)

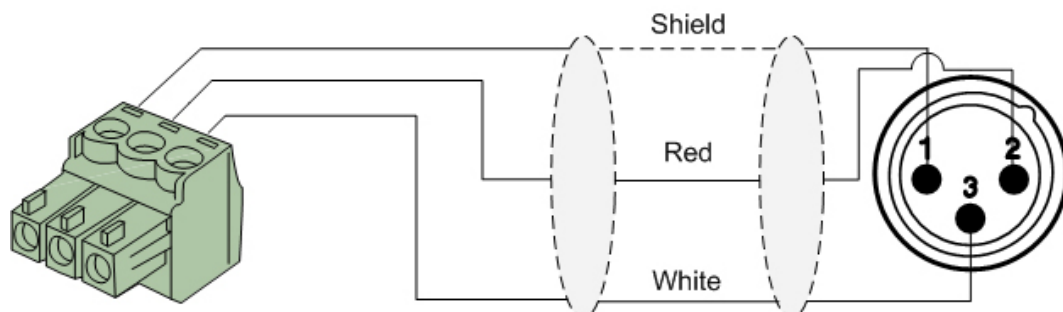

### RJ45 (RS485, Audio, +24V DC):

For connection to Wall Panels

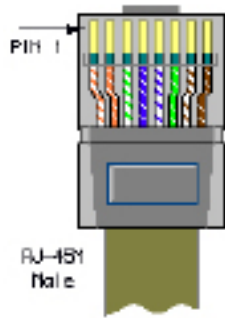

|              |              |                 |
|--------------|--------------|-----------------|
| <b>Pin 1</b> | White–Orange | Remote Input 1+ |
| <b>Pin 2</b> | Orange       | Remote Input 1– |
| <b>Pin 3</b> | White–Green  | +24V DC         |
| <b>Pin 4</b> | Blue         | RS485 A         |
| <b>Pin 5</b> | White–Blue   | RS485 B         |
| <b>Pin 6</b> | Green        | GND             |
| <b>Pin 7</b> | White–Brown  | Remote Input 2+ |
| <b>Pin 8</b> | Brown        | Remote Input 2– |

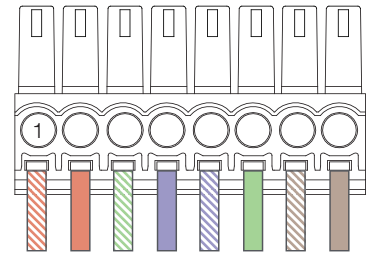

For connection to Paging console

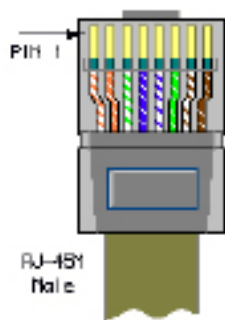

|              |              |                |
|--------------|--------------|----------------|
| <b>Pin 1</b> | White–Orange | Not used       |
| <b>Pin 2</b> | Orange       | Not used       |
| <b>Pin 3</b> | White–Green  | +24V DC        |
| <b>Pin 4</b> | Blue         | RS485 A        |
| <b>Pin 5</b> | White–Blue   | RS485 B        |
| <b>Pin 6</b> | Green        | GND            |
| <b>Pin 7</b> | White–Brown  | Paging audio + |
| <b>Pin 8</b> | Brown        | Paging audio – |

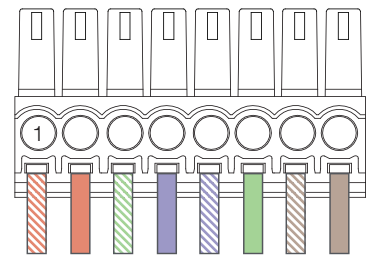

#### ATTENTION

The twisted pair cabling must always be 'straight'. In case of self-made cabling it must be wired as described above, to ensure a proper functioning of the system.

### RS232 (serial connection interface):

For connection with home automation systems, or other remote control equipment

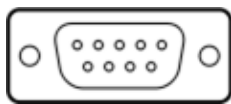

|                   |                |
|-------------------|----------------|
| <b>Connection</b> | Standard RS232 |
| <b>PIN 2</b>      | MTX TX         |
| <b>PIN 3</b>      | MTX RX         |
| <b>PIN 5</b>      | GND            |

|                 |                |
|-----------------|----------------|
| <b>Settings</b> | 19200 Baud     |
|                 | 8 Bit          |
|                 | 1 Stop bit     |
|                 | No parity      |
|                 | No Handshaking |

#### RS232 / RS485 / TCP/IP

The MTX has RS232, RS485 and TCP/IP ports which all accept the same commands. The complete command set to control the MTX is available in the MTX commands user manual which is freely downloadable on [www.audac.eu](http://www.audac.eu)

# Wire up the system

The wiring of the system must be done according to the following rules, to guarantee a proper functioning of the system in all circumstances.

1. Wall Mounted Input & Control units:
  - MWX43/45 UTP/FTP Cat5e cable or better
  - MWX65 UTP/FTP Cat5e cable or better
  - MPX48/88 UTP/FTP Cat5e cable or better
  - WLI18/WMI16 UTP/FTP Cat5e cable or better
  - APM1xxMkII UTP/FTP Cat5e cable or better
  
2. Speaker cable for amplified zone outputs:
  - Minimum 2 x 1.5 mm<sup>2</sup>*
  - If distance > 15 m: 2 x 2.5 mm<sup>2</sup>)*
  
3. Music sources and zone outputs:
  - Must be connected with high–quality audio cable and high–quality connectors*
  
4. Ethernet connection:
  - UTP/FTP Cat5e cable or better*

# Chapter 2

## Front & rear panel

### Front Panel overview

#### MTX48

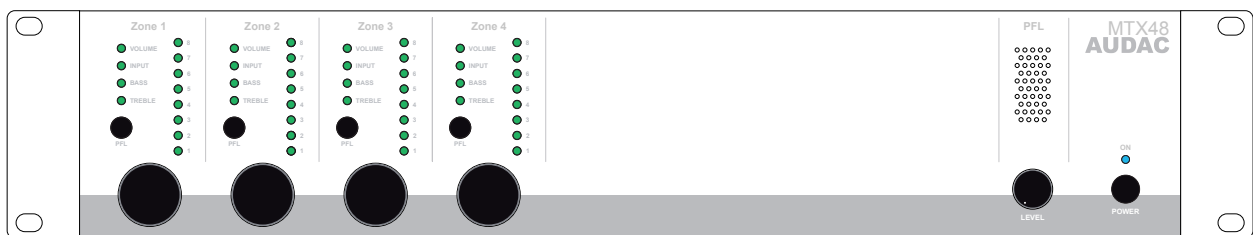

#### MTX88

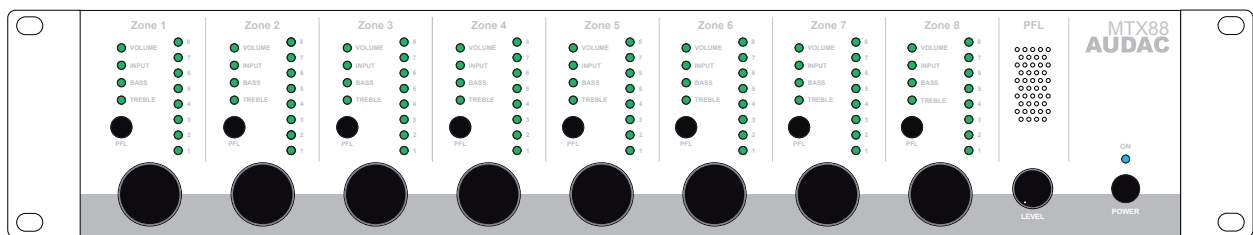

The front panel of the MTX enables you to fully control and configure the settings of every output zone. Every output zone contains its own specific control section, including one rotary function dial, four function indication LED's, and eight level / selection indication LED's.

A built-in pre-listening loudspeaker makes it possible to pre-listen every output channel without requiring additional headphones. The channel which is currently playing through the built-in pre-listening loudspeaker can be selected by means of the PFL selection switches which are provided with each zone control section. The level of the PFL loudspeaker can be controlled by using the PFL potentiometer.

On the right side there is a power button provided. Simply push this button to power-up the system.

# Front Panel functions

The control section for every zone contains one rotary function dial, four function indication LED's and eight level / selection indication LED's.

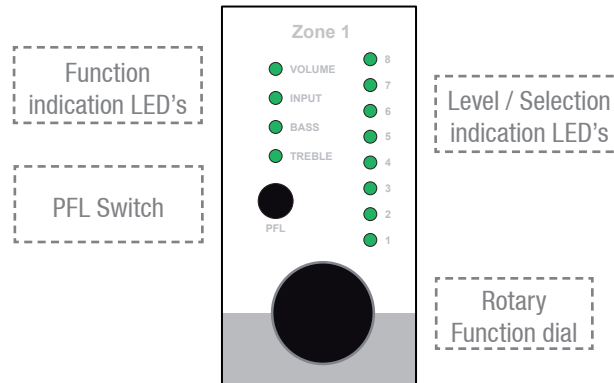

By means of the function indication LED's, the current operating function will be indicated. The upper LED stands for volume adjustment, the second LED stands for input channel selection, the third LED will blink when Bass tone adjustment is enabled, and the fourth LED will blink when Treble tone adjustment is enabled.

The selection of which function has to be controlled can be done by pressing the rotary function dial. When pressing the rotary function dial, the 'Volume' LED will illuminate. Changing to the desired function can be done by rotating the function dial. The currently set level / selection will appear when the function is selected. When any change needs to be made to the level / selection, the rotary button should be pressed a second time. The LED of the selected function will start blinking now, and any rotation to the function dial will affect the set level / selection.

When the level / selection is changed to the desired level and any other change needs to be made, you can return to function selection by pressing the rotary button again. The settings menu will be quit automatically when the rotary dial is not operated for about 6 seconds.

## Volume adjustment:

When no function is selected (MTX in idle status) and the function dial is rotated, the volume adjustment function will be automatically activated. The volume LED will start blinking and the current volume level will illuminate on the level / selection LED's. Manual switching to volume mode can also be done, by the procedure as described above. The level / selection LED's will indicate the currently set volume level. Only a few illuminated LED's correspond with a low volume level, and many illuminated LED's correspond with a high volume level. Rotating the rotary function dial in clockwise direction results in an increasing volume level and rotating in counter-clockwise direction results in a decreasing volume level.

## Input selection:

The desired input channel for every zone can be selected. Every LED corresponds with an input channel, and the corresponding LED for the selected input channel will illuminate when selected. Switching between the different input channels can be done by rotating the function dial. The table shown below gives an overview of which number corresponds with which input channel.

| Input number | Corresponding channel |
|--------------|-----------------------|
| 1            | Microphone Input 1    |
| 2            | Microphone Input 2    |
| 3            | Line input 3          |
| 4            | Line input 4          |
| 5            | Line input 5          |
| 6            | Line input 6          |
| 7            | Remote input 1 (7)    |
| 8            | Remote input 2 (8)    |

### Bass and Treble adjustment:

The Bass and Treble adjustment can be done on a similar way. When the desired function is selected, the corresponding function LED will start blinking. The adjustment can be done by rotating the function dial. Similar to the volume adjustment, clockwise rotation results in a level increase while counter-clockwise rotation results in a level decrease. When the level is set in neutral position (0 dB), no LED's of the level / selection LED's will illuminate. When an amplification (dB +) is selected, the upper four LED's will illuminate from out the centre, depending on the selected level. When an attenuation is selected (dB -), the lower four LED's will illuminate from out the centre, depending of the selected level.

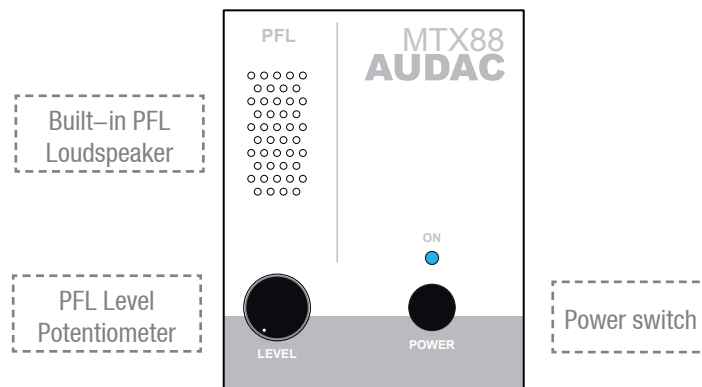

### Built-in PFL Loudspeaker and potentiometer:

The built-in pre-listening loudspeaker makes it possible to pre-listen every output channel without the need for an additional headphone. The channel which is currently playing through the built-in pre-listening loudspeaker can be selected by means of the PFL selection switches which are provided with each zone control section. The level of the PFL loudspeaker can be controlled by using the PFL potentiometer.

### Power switch:

By means of the power switch, the device can be turned ON and OFF. When the device is switched on, the blue LED above the power button will illuminate.



# Functions overview

| Operation functions    |   |
|------------------------|---|
| <b>Change Volume</b>   | <ul style="list-style-type: none"> <li>– Set function LED to ‘Volume’</li> <li>– Push rotary dial once</li> <li>– Rotate function dial to desired volume level<br/>→ <i>The indication LED’s show the selected volume level</i></li> <li>– Push rotary dial once to return back to main menu</li> </ul>   |
| <b>Change Routing</b>  | <ul style="list-style-type: none"> <li>– Set function LED to ‘Routing’</li> <li>– Push rotary dial once</li> <li>– Rotate function dial to desired input channel<br/>→ <i>The indication LED’s show the selected input channel (1–8)</i></li> <li>– Push rotary dial once to return back to main menu</li> </ul>  |
| <b>Change Bass</b>     | <ul style="list-style-type: none"> <li>– Set function LED to ‘Bass’</li> <li>– Push rotary dial once</li> <li>– Rotate function dial to desired bass level<br/>→ <i>The indication LED’s show the selected level</i> <ul style="list-style-type: none"> <li>– <i>In neutral position, all LED’s are off</i></li> <li>– <i>Increased level causes upper LED’s to illuminate</i></li> <li>– <i>Decreased level causes lower LED’s to illuminate</i></li> </ul> </li> <li>– Push rotary dial once to return back to main menu</li> </ul>     |
| <b>Change Treble</b>   | <ul style="list-style-type: none"> <li>– Set function LED to ‘Treble’</li> <li>– Push rotary dial once</li> <li>– Rotate function dial to desired treble level<br/>→ <i>The indication LED’s show the selected level</i> <ul style="list-style-type: none"> <li>– <i>In neutral position, all LED’s are off</i></li> <li>– <i>Increased level causes upper LED’s to illuminate</i></li> <li>– <i>Decreased level causes lower LED’s to illuminate</i></li> </ul> </li> <li>– Push rotary dial once to return back to main menu</li> </ul> |
| <b>Pre–Fade Listen</b> | <ul style="list-style-type: none"> <li>– Press PFL button<br/>→ <i>Selected channel now plays through the built–in loudspeaker</i></li> </ul>   |
| <b>Save Settings</b>   | <ul style="list-style-type: none"> <li>– Hold rotary button for Zone 1 and Zone 2 for 3 seconds<br/>→ <i>Saved settings will be recalled after MTX restart</i></li> </ul>   |

| Configuration functions                      |   |
|--|---|
| <b>Priority 1 Enable / Volume (per zone)</b> | <p>Priority message from Microphone Input 1 will be announced to priority enabled zones.</p> <ul style="list-style-type: none"> <li>– Set LED for corresponding zone to ‘Volume’</li> <li>– Hold rotary button for corresponding channel down for 3 seconds<br/><i>(Volume LED starts blinking)</i></li> <li>– Priority can be enabled and volume can be set by rotating the button<br/><i>(Priority is disabled when volume is set to zero)</i></li> <li>– Press rotary button once again to return back to main menu</li> </ul> |

| <b>Configuration functions</b>               |   |
|--|---|
| <b>Priority 2 Enable / Volume (per zone)</b> | <p>Priority message from Microphone Input 2 will be announced to priority enabled zones.</p> <ul style="list-style-type: none"> <li>– Set LED for corresponding zone to ‘Routing’</li> <li>– Hold rotary button for corresponding channel down for 3 seconds (<i>Routing LED starts blinking</i>)</li> <li>– Priority can be enabled and volume can be set by rotating the button<br/>(<i>Priority is disabled when volume is set to zero</i>)</li> <li>– Press rotary button once again to return back to main menu</li> </ul>   |
| <b>Paging Volume (per zone)</b>              | <p>Paging volume for message from External Paging Console can be set.</p> <ul style="list-style-type: none"> <li>– Set LED for corresponding zone to ‘Bass’</li> <li>– Hold rotary button for corresponding channel down for 3 seconds (<i>Bass LED starts blinking</i>)</li> <li>– Paging volume can be set by rotating the button<br/>(<i>Paging is disabled when volume is set to zero</i>)</li> <li>– Press rotary button once again to return back to main menu</li> </ul>   |
| <b>Mono / Stereo output (per zone)</b>       | <p>Output signal for each zone can be switched between Mono and Stereo</p> <ul style="list-style-type: none"> <li>– While powering–up the device, hold the rotary button for Zone 1.<br/><i>The Mono / Stereo settings menu will be displayed</i></li> <li>– Toggling between Stereo or Mono mode can be done by using each zones’ rotary button <ul style="list-style-type: none"> <li>– <i>LED 1: Zone set to Mono</i></li> <li>– <i>LED 2: Zone set to Stereo</i></li> </ul> </li> <li>– Power off and Power on the device again to go back to normal operation mode.</li> </ul> |
| <b>Set Wall Panel Address</b>                | <p>Connected wall panels can be assigned to one zone.</p> <ul style="list-style-type: none"> <li>– Set LED for corresponding zone to ‘Treble’</li> <li>– Hold rotary button for corresponding channel down for 3 seconds (<i>All connected wall panels will start blinking</i>)</li> <li>– Press upper button from the wall panel to assign this wall panel to the corresponding zone</li> <li>– Repeat this action to assign multiple wall panels to this zone</li> </ul>  |

# Rear Panel overview

## MTX48

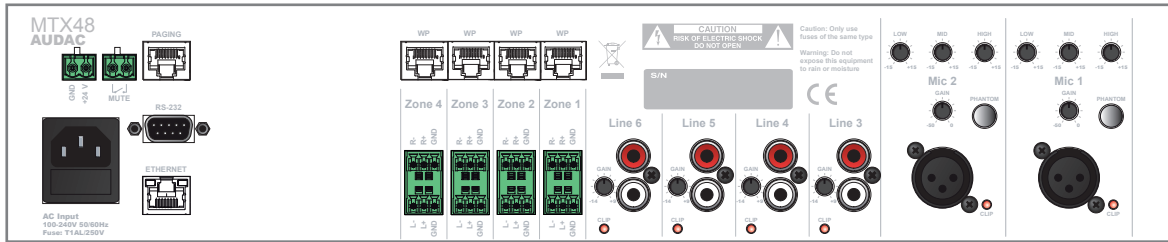

## MTX88

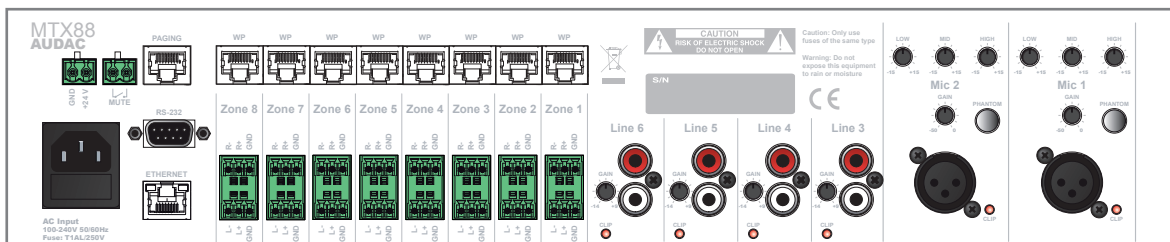

The rear side of the MTX contains all different kinds connectors which are necessary to connect the device.

### Power, Mute, RS232, Ethernet & Paging connectors:

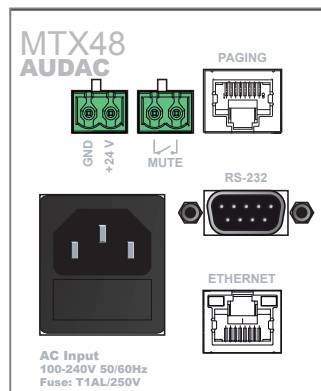

#### Power inlet:

The mains power supply (110~240V AC / 50~60 Hz) has to be applied to this AC power inlet. The connection is made by an IEC power connector and is fitted with a fuse. When replacing the fuse, make sure that the value of the replacement fuse matches the value of the original fuse. (T1AL/250V)

#### Emergency power inlet (24 Volt):

A 24 Volts emergency power supply can be connected to this 2-pin Terminal block connector for keeping the MTX running on emergency power when the mains power is shut down. When the MTX is running on 24 Volt emergency power, the function of the power switch on the front panel is bypassed and can't switch the MTX off.

**Mute Connection:**

A priority mute contact connection is present which allows complete muting of background music at presence of a contact closure between both 'MUTE' contacts. This Contact is convenient for situations where a for example a separate emergency system is installed and complete background music muting is required. For example at the occasion of a fire alarm. The emergency system output contacts can be linked to this contact input.

**RS232 Connection:**

The RS232 connection can be used to control the MTX through external hardware such as an home automation system or computer. Connect your external control hardware to this port. The pinout and communication settings are described in an earlier chapter of this user manual. The complete RS232 command instruction set and configuration information can be downloaded from the AUDAC website.

**Ethernet RJ45 Connector:**

This connector should be connected to a LAN Network. This makes it possible to control the MTX over Ethernet. The control can be done by sending commands over TCP/IP, by a device with a standard web browser supporting flash or by using special apps which are designed to be used in combination with mobile applications. (Smartphones & Tablets) For more information about the Ethernet configuration of this device, check 'Chapter 4: User interface & Configuration' and 'Chapter 6: IP Basics' of this user manual.

**Paging RJ45 Connector:**

The (optional) MPX paging consoles must be connected to the 'PAGING' RJ45 connector. This allows to announce messages through the microphone of the paging console to all the zones of the MTX. The selection of which announcements should be made in which zone can be done on the control panel of the MPX paging consoles. (MPX48–4 zone for MTX48 and MPX88–8 zone for MTX88)

**Wall Panel & Zone output connectors:****Wall Panel RJ45 Connectors:**

Every zone has its specific Wall Panel (WP) RJ45 connector where additional wall panels can be connected to. Every zone has the possibility to connect an additional Line and Microphone input unit and multiple wall panel controllers. On these ports are both digital RS485 control signals as well as differential audio signals transmitted.

### Zone outputs (Terminal Block):

The zone outputs of the MTX are stereo (switchable to mono) balanced line–level outputs. Depending on the requirements for each specific application, the suitable amplifiers should be connected to these output connectors. The used connectors are 3–pin Terminal–Block connectors.

### Input connectors:



### RCA / Cinch Line inputs:

Unbalanced Line–Level input sources (E.g. CD–Players, Tuners, MP3 Players, ... ) should be connected to the Line level inputs Line 3 to Line 6. These are standard line–level stereo inputs performed with RCA connectors. All of them have a gain control potentiometer whereby the level of the input signal can be controlled within a range of –14 dB ~ +9 dB.

The clipping LED illuminates when the signal reaches the clipping level.

### Balanced microphone inputs:

Balanced mono sources (E.g. Microphones) should be connected to inputs Mic 1 and Mic 2. Both channels are performed with Female XLR connector provided with gain control potentiometer whereby the level of the input signal can be controlled within a range of –50 dB ~ 0 dB. This makes it possible to connect both Line level input sources as well as Microphone level input sources. The clipping LED illuminates when the signal reaches the clipping level.

In addition, both channels have a three–band tone control, whereby specific frequency ranges can be adjusted within a range of  $\pm 15$  dB and a phantom power switch, whereby the 15 Volts phantom power can be enabled for powering condenser microphones.

# Chapter 3

## MTX Quick start guide

This chapter guides you through the setup process of a basic project with one MTX audio matrix and 8 standard MWX43/45 wall panels, two All-In-One MWX65 wall panels and some regular Line & Microphone input sources.

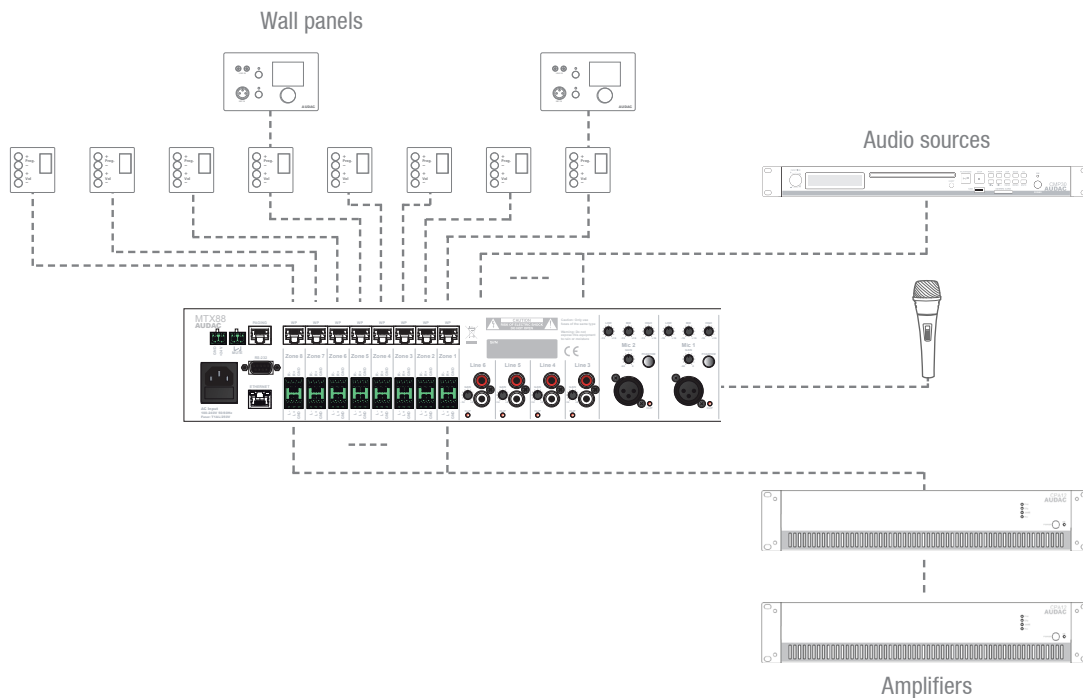

Overview of the MTX setup

## Connecting the MTX

### ATTENTION

Make sure the power of the device is turned OFF before any connections or wiring adjustments are made. Disregarding this rule can lead to permanent damage of the equipment

### 1) Connecting audio sources

Connect all the Microphones to the XLR connectors on the rear side of the MTX. When using condenser microphones, make sure the phantom power switch is turned ON. Connect all the Line-Level audio sources (CD-Players, MP3 Players, Tuners, ...) to the RCA connectors on the rear side of the MTX. Adjust all input gains to the appropriate level so no input clipping occurs.

### 2) Connecting amplifiers and/or speakers

Connect amplifiers (100V or Low impedance) to the balanced outputs of the MTX (Three-pin Euro-Terminal Block). The amplifier configuration (100V or Low impedance) and power needs to be chosen according to the requirements for each specific application. In its standard configuration, the MTX has Balanced Stereo outputs, which can be switched to Balanced Mono outputs. (See configuration functions)

### 3) Connecting wall panels

Connect the MWX43/45 and MWX65 wall panels to the Wall–Panel (WP) inputs (RJ45 connectors) for each zone. Multiple MWX43/45 wall panels can be connected to one single WP input by using bus cabling (connecting all the wall panels in parallel). The assignment of which wall panel is controlling which zone can be done by software configuration (See configuration functions). Only one All–In–One Wall Panel with additional audio input can be connected to one WP input.

### 4) Connecting a computer

A computer can be connected to the MTX through Ethernet. If the computer is directly connected to the MTX, a crossed network cable is necessary. If the MTX is connected to a local LAN network (connected to a router / switch / hub) a straight network cable is necessary. Ask your IT administrator for help.

To get access to the user interface, enter the following address in your internet browser address bar: “http://192.168.0.192” (This is the factory default IP address of the MTX which can be changed in the user interface). The default administrator password (gives you access to all functions) is “MTX” and the default user password (gives you only access to the basic functions) is “user”. If you want to make any changes to the settings, you should log–in with the administrator password.

## Configuring the MTX

### 1) Changing the IP address

You can skip this step when the default IP address “192.168.0.192” is not used by another device in your network, and is OK for you. If you like to change the IP address, go to the “Setup” menu (click the icon in the upper right corner of the main screen) and click “Network Settings”. Now you can change the IP address, and click “OK” to apply the changes and save. Afterwards, your browser will be automatically redirected to the new IP address of the MTX, and the default IP address is not longer valid.

### 2) Changing the password

You can skip this step if the default password “MTX” for administrator and “user” for users is OK for you. Though, if the device is connected to a public network, it’s highly recommended to change the default passwords. If you’d like to change the password(s), go to the “Setup” menu and click “Password settings”. Here you can change the passwords. First, the old password needs to be entered, and subsequently the new password needs to be entered twice (Max 8 characters). Press the “OK” button to save the new password. Now, you always need to log–in with the new passwords and the default passwords are not longer valid.

### 3) Configuring wall panels and sources

Go to the “Setup” menu and click “System configuration”. Now you have the possibility to choose between “MWX65” and “MWX43/45”.

To configure the settings for the MWX43/45 wall panels, click the corresponding button. By the drop down list the zone can be chosen for which a wall panel should be assigned. After the zone is selected, click the “Set Address” button. The displays on all connected wall panels will start blinking with the selected zone number. Push the upper button “Program +” on the wall panel which should be assigned with that particular zone. After the “Program +” button is pressed, the wall panel will be linked with the selected zone and the display will stop blinking. Repeat this action for all the connected wall panels and for all zones until a zone is assigned for every connected wall panel.

To configure the settings of the MWX65 wall panels, go back to the “Setup” > “System configuration” menu, and click the “MWX65” button.

After this button is clicked, a window will be shown where all the configuration settings for the MWX65 can be made. On the left side, a drop down list is shown whereby the address for the MWX65 can be selected. The address can be selected between “W001” to “W008”. Logically it starts with the address “W001” for the first wall panel and increases the address for every subsequent wall panel. After the desired address is selected, click the “Set Address” button and the display on the MWX65 will start blinking. Confirm the address of the wall panel by pushing the big rotary button on the wall panel and the selected address will be assigned to the wall panel.

After this is done, the zone which should be controlled by this wall panel can be selected by the drop down list which is shown one position to the right.

The inputs which are selectable with the wall panel can be chosen in the “Selectable inputs” drop down list. After the inputs are clicked, all the selected inputs will appear in the listbox shown below.

Certain actions such as Volume Change, Input change, Mute, Tone control and settings can be disabled from the wall panel and the phantom power on the microphone input can be enabled by clicking the check boxes.

Finally, the display backlight level and screensaver settings can be adjusted.

After all settings are done, click the “Save to Wallpanel” button and all your settings will be send to the selected MWX65 wall panel. Repeat this action for all the connected MWX65 Wall Panels.

## Ready

Your system is now completely configured and ready to be used.



# Chapter 4

## User interface & configuration

To get access to the control and configuration settings, the MTX should be connected to a computer or an Ethernet LAN network. For more information about network connections and settings, see IP basics in chapter 6.

The standard (factory default) IP address of the MTX is 192.168.0.192, make sure this address is within the IP range of the connected Ethernet LAN network (subnetmask 255.255.255.0). If the default network address is not within range of your LAN network, contact your network specialist. The network address can be changed with the Standard Web Based User Interface but therefore a network connection has to be made first!

Any device (PC, Laptop, PDA or even a Smartphone) with a web browser and the Macromedia Flash 8.0 plug-in (or higher) installed, can be used to control the web based user interface.

For smart devices a special application has been developed to control the MTX Matrix.

AUDAC Touch™ total system control platform. Using this freely available solution, application specific dashboards can be created and customized, allowing the control for multiple devices from one single application. <https://audac.eu/>

## Open the user interface

Start your default web browser and enter the IP address of the embedded web server of the MTX in the address bar. (The factory default IP address is <http://192.168.0.192>).

## Login screen

First the login screen will be displayed.

A password should be entered to get access to the web interface of the MTX matrix. There are two different access levels, **administrator** level and **user** level.

If you log-in using the **administrator** password, you get access to all functions and configuration options of the MTX Matrix (The factory default password for administrator access is “MTX”).

When you log-in using the **user** password, you only get access to the basic functions of the MTX matrix, such as changing the volume and changing the routing for a particular output zone. (The factory default password for user access is “user”).

After the right password is entered, click the “OK” button, and you will be redirected to the main screen of the MTX interface.

### NOTE

The passwords can be changed in the Configuration >> Password settings menu (Only administrator)

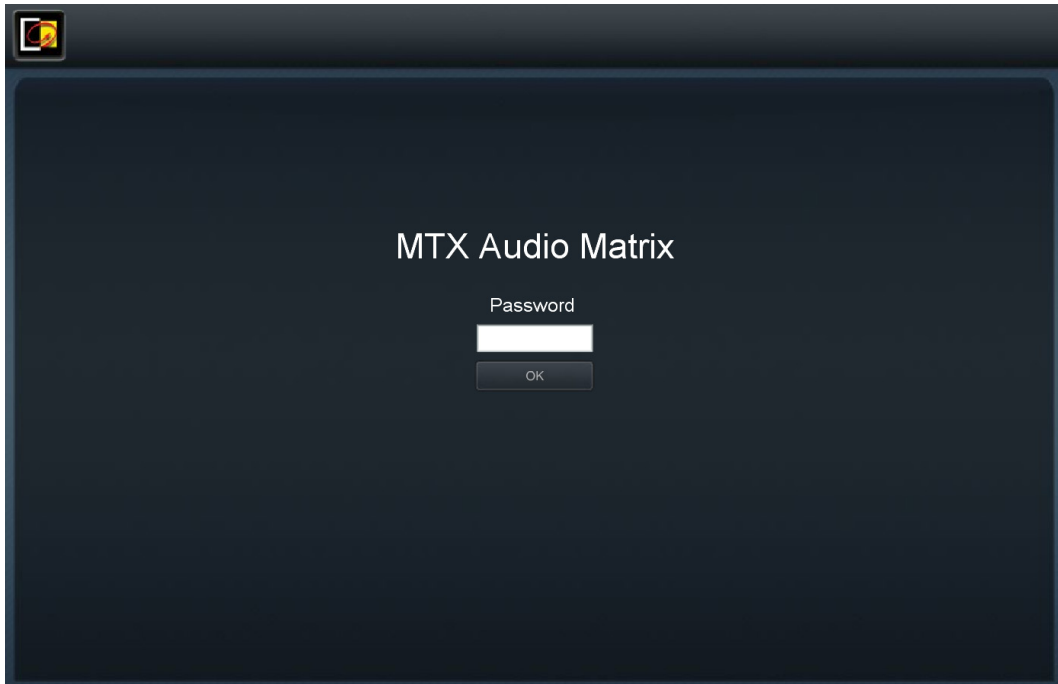

*MTX Login screen*

## Main screen

The main screen displays all the output zones with fader volume controls. (4 zones for MTX48 and 8 zones for MTX88)

### **Volume control**

The volume of each channel can be set by moving the fader of the corresponding channel up or down. At the top and bottom side of each fader is a button with an arrow displayed whereby the volume can be raised or lowered in steps of 1 dB. At the bottom is a “Mute” button provided which mutes the volume of the corresponding output channel in one click. After the volume is muted, this mute button will become Red, and the volume can be unmuted after clicking it again.

### **Assign zone names**

For a better overview of all output channels, every fader can be assigned by a specific zone name as shown in following example. The name of the zone can be changed by double clicking on the name which is displayed above the corresponding fader. When a cursor comes up, remove the existing name with the backspace key, and change the name in the desired name. Click on the “Save Zone Settings” button and confirm to save the changed zone settings. The name of the corresponding zone will be changed, and next time you log in to the web based user interface, the same zone names will be displayed.

### **Connection status**

In the top left corner of the window is the “Connection Status” displayed. To have communication with the MTX, the connection status must be “ONLINE”. In normal operation, the status “ONLINE” will be indicated in green. When the status “ONLINE” is shown in orange, it means the communication with the matrix was interrupted but is restored now. When the status “OFFLINE” is shown in red, it means there is currently no communication with the matrix.

## Input channel selection

The desired input signal for a particular zone can be selected by using the drop down list box below the zone name. This drop down list shows the 8 input signals (in case all 8 are enabled). When no input signal is selected, the option “Off” will appear.

## Save

When any important changes are made, press the “Save” button in the top right corner. When the settings are saved, it will be recalled after MTX restart.

## Configuration menu

In the top right corner is a “Setup” button displayed. After clicking this button, you will be redirected to the general configuration menu of the MTX.



MTX Main screen

# Zone settings

After clicking on a “Settings” button for a specific zone, you will be redirected to the “Zone Settings” window. This window gives an overview of all the settings that can be applied to one specific zone.

## Input selection

This window gives an overview of all channels which can be patched to that particular zone output. The first displayed option is ‘No Input’, which means when this option is selected, no input signal will be routed to that particular output zone. Below are all 8 inputs displayed which can be patched to that particular output zone.

## Direct inputs

The first 6 displayed inputs are all direct inputs which are available on the back side of the MTX. The first two are the microphone channels Mic 1 and Mic 2. The four next ones are Line inputs Line 3 to Line 6. These six ‘Direct Inputs’ are simultaneously available and selectable for all output zones of the MTX.

## Wall panel inputs

The other two inputs (Inputs 7 and 8) are wall panel inputs. These input signals are coming from external Wall Panel input devices, which are patched to the Wall Panel (WP) RJ45 connectors on the MTX. These zone inputs are separately for every zone, and not linkable with other zones. Input 7 is the “remote input 1”, containing the signal coming from external All-in-one (MWX65) or Line (WLI) input units. Input 8 is the “remote input 2”, containing the signal coming from external Microphone (WMI) input units.

## Two-band tone control

On the right side of the window there are two faders displayed whereby the sound settings can be adjusted through two-band tone control. The left most fader indicated with “Bass” offers the possibility to adjust the level of the low frequencies, while the right most fader indicated with “Treble” offers the possibility to adjust the level of the high frequencies. The sound level for both low and high tones can be amplified or attenuated between +14 dB and -14 dB. This can be easily done by sliding the faders up and down.

## Assign input names

For a better overview of all the inputs, a name can be assigned to every specific input. The name of the input can be changed by double clicking on the input name shown in the “Zone Settings” screen. When a cursor comes up, remove the existing name with the backspace key, and just change the name into the desired name. After the desired input names are entered, they will be stored automatically when pushing the “Back” button and will be recalled when reloading the MTX interface.

## Input selection

In the “Input Selection” menu can be selected which inputs should be made available in the “Quick Selection Menu” for this zone.

“Copy setting to other output” Its the user copy the down-down selection to other zones.

## Back

Click the “Back” button to go back to the main window.



MTX Zone settings screen

# Zone settings >> Input selection

The input selection window allows you to make a selection out of all available input signals for the “Quick Selection Menu”. This menu is the drop down list which is shown on the main screen below the zone name, but also the inputs selectable by the MWX43/45 wall panels are defined by the “Quick Selection Menu”.

## Selection

This window gives an overview of 8 list boxes, one for every selectable input channel. In every list box, the selection can be made between the “input name” and “Off”. When switched to “Off”, the input channel is not selectable for this zone.

## Copy

Using the drop–down box, then clicking “Copy” the currently displayed Input selection can be copied to any zone.

## Save

After the selectable inputs for this zone have been selected, click the ‘Set inputs’ button and the selected inputs will be assigned with this zone.

## Back

Click the “Back” button to go back to the previous window.

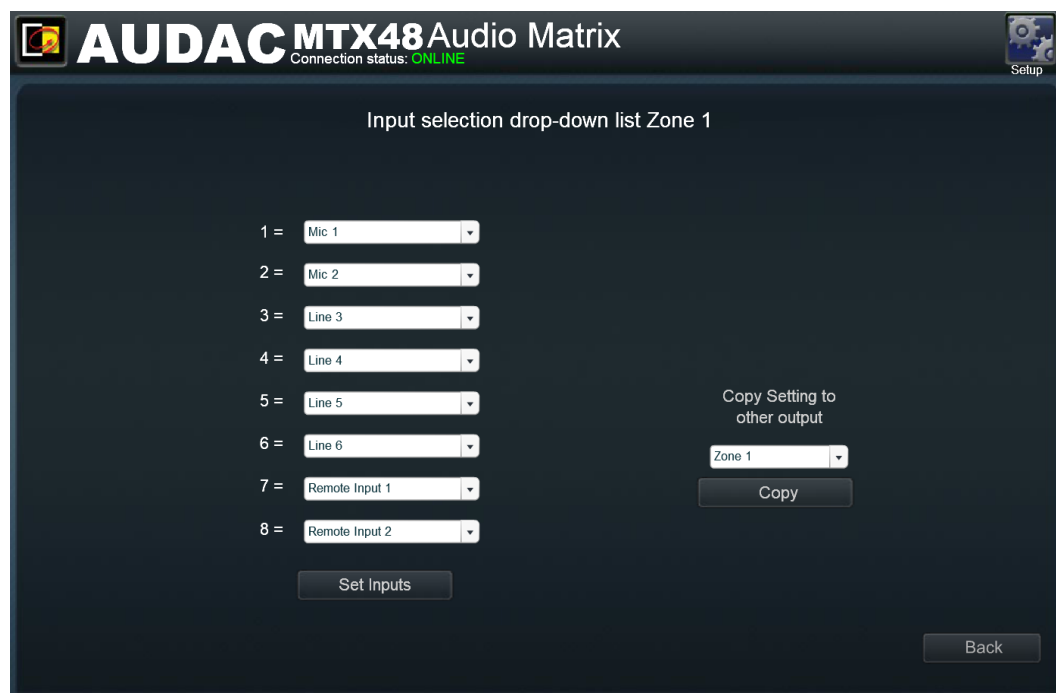

*MTX Input selection screen*

# Configuration settings screen

The configuration settings control panel comes up after clicking the “Setup” button. This button is always shown in the upper right corner of every window. (Only on Administrator level)

In this window, all the settings of the MTX can be made such as adjusting the network settings, adjusting the paging settings, changing the priority settings, making the system configuration for external connected devices, changing the password and restoring the settings to factory default.

If you want to change some settings, just click on the corresponding icon.

## Auto saving

All changes made to configuration settings will be saved automatically and are still effective after shutdown of the device.

## Back

Click the “Back” button to go back to the main screen.



*MTX Configuration settings screen*

## Settings >> Paging Volume

In this window, the paging volume for each individual zone can be set by means of the drop down boxes. This part is more extensively described in “Chapter 5: Peripheral interfaces >> Paging” of this user manual.



*MTX Paging volume screen*

## Settings >> Priority settings

The priority settings menu makes it possible to set the priority for direct microphone inputs Mic 1 and Mic 2. When a microphone input has priority in a certain zone, all the other audio sources will be suppressed for that zone when a signal is applied to one of the priority inputs.

Directly below the Mic 1 priority and Mic 2 priority, you'll see a sensitivity menu, accompanied by a hold menu. The sensitivity drop down menu allows you to configure how well the MTX registers an input. When sensitivity is set to high, a low input signal (low volume) at a priority input is sufficient in order to trigger the priority mode. When sensitivity is set to low, you need to have a relatively large input signal (e.g. speak relatively loud) to trigger the priority function. The hold menu sets the time the audio sources are still suppressed when the priority procedure is over. This value can be set from 1 second to 5 seconds.

### **Priority enabling / volume**

This priority settings window shows an overview for both microphone channels Mic 1 and Mic 2 with list boxes for every output zone of the MTX. With the list boxes, the priority can be enabled and the level can be set.

Standard, all list boxes are switched to “Disabled”.

When a microphone input should have priority in a certain zone, the condition should be changed from “Disabled” to the desired level. The desired level can be selected by steps of -1 dB in a range between 0 dB and -64 dB. When the level is set to 0 dB, the priority

messages for that zone will be announced on maximum volume.

The switching to and from a priority signal is done according to the **HARDIN – FADEOUT** principle. This means when a priority situation occurs (signal present on the priority inputs), immediately will be switched to this channel. When the priority situation is over (no more signal present on the priority inputs), the status will return back to the initial status by fading the sound in.

### Sensitivity

The sensitivity of the input detection is set by means of adjusting the selection box between high, medium and low.

### Hold

The hold time after the priority has ended and any selected audio return is set using the down–down menu box, selection options are in increments of 1 second between 1–5 sec.

Click the “OK” button to confirm the priority settings.



*MTX Priority settings screen*

### PRIORITY RANK

When a priority situation occurs and various priority enabled inputs are triggered at the same time, the priority rank will be in following order:

- 1) Mic 1 input (Highest priority)
- 2) Mic 2 input
- 3) Paging input (Lowest priority)



## Settings >> System configuration

In this window, the configuration settings for external connected devices such as wall panels and paging consoles can be made. It shows four buttons, one for MWX43/45 whereby the configuration settings for the simple wall panel controller can be made, one for MWX65 whereby the configuration settings for the All-In-One wall panel can be made, one for paging whereby the configuration settings for APM and MPX paging consoles can be made.

Click the corresponding button to proceed to the desired settings menu.



### Note

For more information about the connection and configuration possibilities for external connected devices, refer to **Chapter 5: Peripheral Interfaces** of this user manual. In this chapter is extensively described how the connection and configuration for peripheral equipment should be done.

### Back

Click the “Back” button to go back to the configuration screen.



*MTX System configuration screen*

## Settings >> Front control settings

This window enables you to block certain settings from being accessible from the front panel of the device. Four check boxes are shown for the corresponding settings, indicating: “Block volume change”, “Block input change”, “Block Bass / Treble change” and “Block configuration settings”. By ticking the check boxes the access to the corresponding settings will be denied from the front panel. It is recommended disabling the configuration settings

from the front panel, when the device will be placed within reach of unqualified personnel.

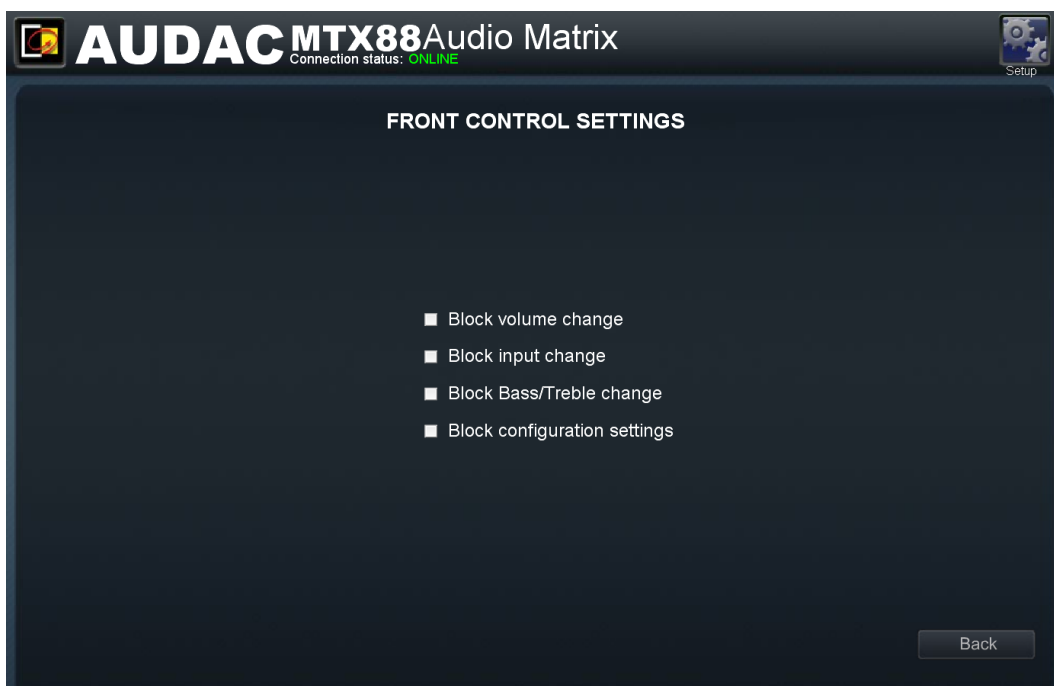

*MTX Front control settings screen*

## Settings >> Mono/Stereo

In this window, the outputs of the MTX can be switched between Mono and Stereo. By clicking the drop down lists, the selection between Mono and Stereo will become visible.

When mono is selected, at both Left & Right outputs an identical signal will be present, which is a mix of the left and right input signals.



*MTX Mono / Stereo selection screen*

## Settings >> Network settings

In this window, the network settings of the MTX can be adjusted. The IP address can be set manually.

The IP address is standard set to 192.168.0.192 and the subnetmask is standard set to 255.255.255.0.

The IP address can simply be changed by changing the value in the corresponding field. After the IP address is changed, you will be automatically redirected to the newly changed IP Address. Click the “OK” button to confirm the network settings.



| NETWORK SETTINGS |               |
|------------------|---------------|
| IP Address       | 192.168.0.192 |
| Subnet Mask      | 255.255.255.0 |
| Gateway          | 192.168.0.253 |
| DNS-server       | 192.168.0.21  |

Cancel OK

*MTX Network settings screen*

## Settings >> Password settings

In this window the passwords for the MTX can be changed. There are two different password levels. Administrator level which has full access to all functions and User level, which has only access to the basic functions.

On the left side of the window the settings for the Administrator password can be changed, while on the right side the settings for the User password can be changed.

For changing the password, enter the old password in the provided field, and enter the new password twice in the provided fields. After this all is completed, push the “OK” button.

When the old password is correct, and the new password filled in both fields match, the old password will be changed into the new password.



### Note

The factory default password for **Administrator** level is “**MTX**” and for **User** is “**user**”.



MTX Password settings

## Settings >> Factory settings reset

### ATTENTION

**BE CAREFUL** to press this button. It really will recall the ORIGINAL factory settings !!!

It does not recall the previously saved settings, but it recalls the original factory setting and the previously made settings will be lost.

Click the “OK” button to reset the settings to factory default.

The following settings will return back to their default value:  
(Default value also shown below)

*Main volume: -20 dB*  
*Selected input: Input 1*  
*Bass: 0 dB*  
*Treble: 0 dB*  
*Mute: Off*  
*Priority 1: Disabled*  
*Priority 2: Disabled*  
*Paging volume: -10 dB*  
*Administrator password: MTX*  
*User password: user*  
*Block front settings: All disabled*  
*IP Address: 192.168.0.192*  
*Subnetmask: 255.255.255.0*  
*All inputs enabled in “Quick Selection Menu”*

# Chapter 5

## Peripheral interfaces

The MTX offers the possibility to connect input and control units in addition to the standard direct line and microphone inputs.

The connections of those additional units should be done to the Wall Panel (WP) or PAGING inputs on the rear side of the MTX. Every zone has its own Wall Panel (WP) RJ45 connector. The wall control panels connected to these inputs can be assigned to any zone. The signal applied to the wall panel inputs can only be patched to the zone it is connected to.

### Available peripheral devices for MTX:

#### **MWX45 Basic wall panel with routing and volume control**

The MWX45 are basic wall panels whereby the routing and volume for one specific zone can be controlled. These wall panels must be connected in a data bus structure, connecting multiple MWX45 Wall panels to one WP input. The assignment of the wall panel with a zone can be done by software assignment. The amount of MWX45 on one data bus is limited to the total current consumption on the MTX power supply, and a total cable distance between the MTX and the last MWX45 within the data bus of 300m.

(How this should be done is described later in this chapter)

#### **MWX65 All-In-One wall panel with graphics display, Line & Microphone input (WP)**

The MWX65 wall panel can be used to control the volume and routing for one zone, but also provides the possibility to control some additional functions such as muting, tone control and phantom power. But the greatest advantage of the MWX65 is that it contains an additional Line and Microphone input which is locally mixed and used as additional local input for that zone on the MTX. It is possible to connect two MWX65 units to each WP input on the back of the MTX.

The total number of MWX65 units that can be connected to any MTX48 or 88 is 8.

#### **Additional Line (WLI) and Microphone (WMI) input units (WP)**

The Line and Microphone input units can be connected to the MTX to create additional local Line and Microphone inputs for that particular zone. The signal coming from the local Line input units (WLI) will be available on Input 7 and the signal coming from the local Microphone input units (WMI) will be available on Input 8, by default.

It is possible to connect two WLI or two WMI to the same zone. The total number of additional WLI and WMI that can be used on an MTX48 or MTX88 is 8 and 16 respectively.

#### **Connection limitations**

Please note that on every WP (Wall Panel) input, two additional audio input devices can be connected. Any combination of MWX65, WLI, WMI is possible in addition to the audio inputs the MWX45 can be added to these data buses.

# Peripheral Equipment Combinations

All RS485 zone input sockets on the MTX 48 and 88 have two inputs, input 7 and input 8. This document will explain how to connect Audac peripheral devices so that input 7 and input 8 can both be used.

## Note

Unlike the other inputs on the MTX (Mic1, Mic2, Input3–6) the RS485 input can only be used locally, on the corresponding zone it is connected to. Below you will see that any combination of peripheral devices is possible:

- MWX65 MWX45
- WLI MWX45
- WMI MWX45
- MWX65 MWX65 MWX45
- MWX65 WLI MWX45
- MWX65 WMI MWX45
- WLI WLI MWX45
- WLI WMI MWX45
- WMI WMI MWX45

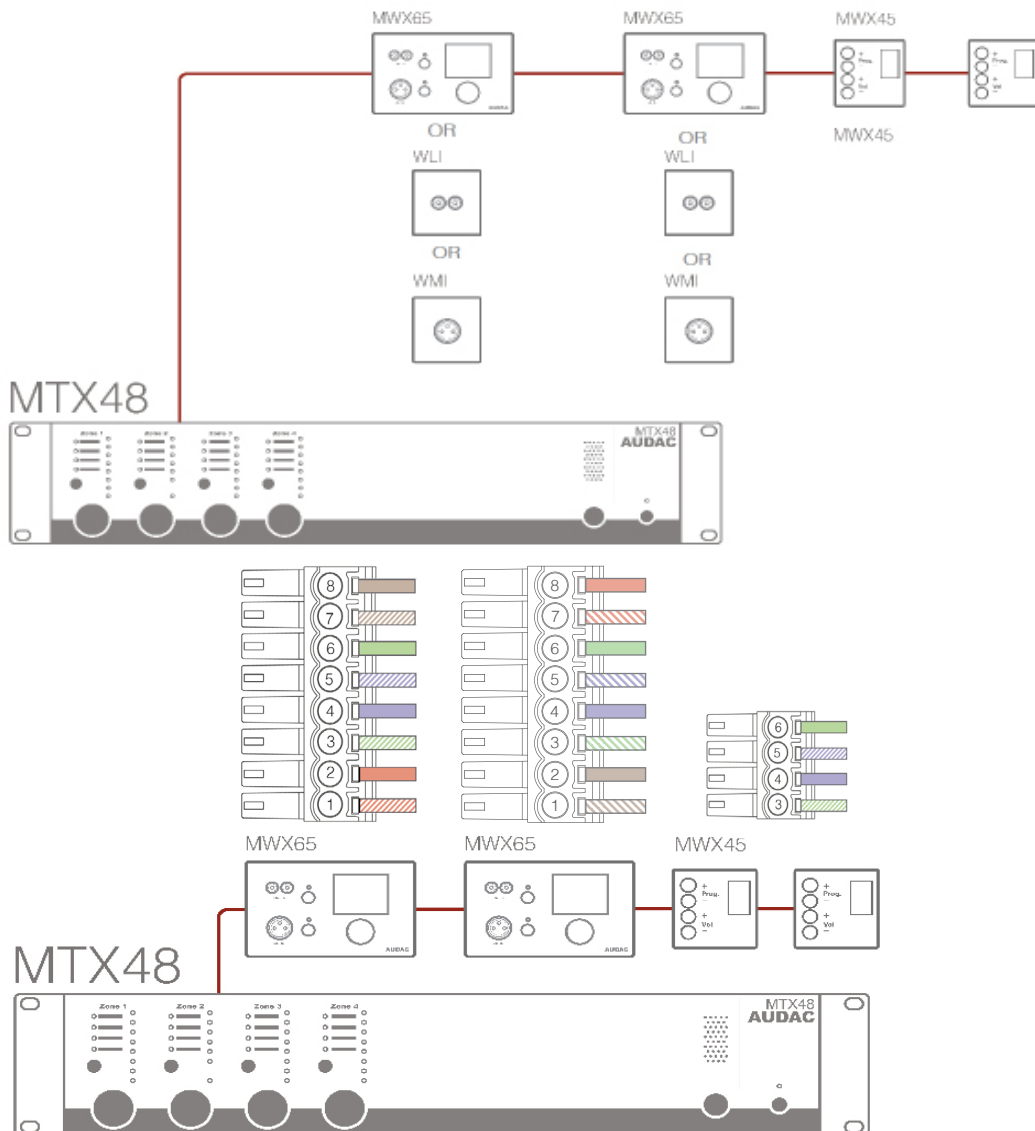

### **APM / MPX Paging consoles (PAGING)**

The APM and MPX Paging systems can be used for paging to different zones of the MTX. Depending on the number of zones of the MTX system (MTX48 or MTX88), associated paging consoles are available for broadcasting to 4 or 8 zones. The paging consoles have to be connected to the specially provided PAGING input and multiple paging consoles can be linked in series, becoming a priority-based paging system.



#### **Note**

Always make sure the MTX is powered off when connecting or disconnecting devices to the WP inputs.

# Wall mounted control panels

The MTX installation can be expanded with additional wall control panels. Two kinds of different wall panels are available. The MWX45 standard wall panel which allows to adjust the routing and volume for one particular zone, and the MWX65 All-In-One wall panel provides the possibility to connect an additional Line or Microphone signal source in a specific zone.

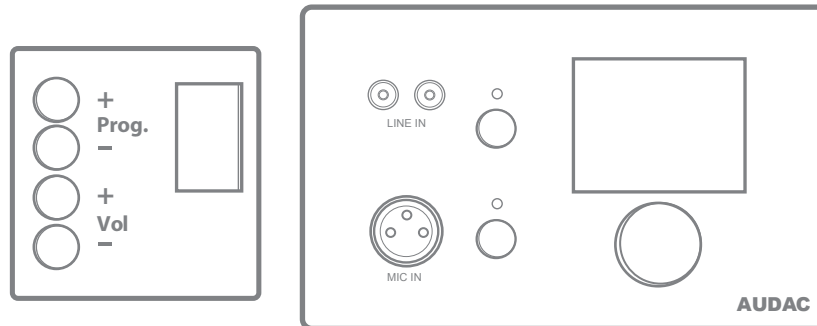

*MWX43/45 (Left) & MWX65 (Right) Wall panels*

These wall panels should be connected to the WP (Wall Panel) ports on the rear side of the MTX with Twisted pair UTP Cat5e (or better) cabling. Multiple MWX45 wall panels can be connected on one single WP (Up to 32 wall panels according to RS485 specification). But only one All-In-One wall panel with audio inputs (MWX65) can be connected on one single WP Port

## MWX45 Basic wall panel

### Functions

The MWX45 is the basic wall panel which allows you to control routing and volume for one specific zone.

### Change routing

The MWX45 display will indicate the current routing for the configured zone, by displaying the number between 1 and 8 on the display. If the “Prog +” button is pressed, the next input will be selected, if the “Prog –” button is pressed, the previous input will be selected.

### Change volume

The volume in the corresponding output zone can be changed by pressing the “Vol +” and “Vol –” buttons. The volume will increase after pressing the “Vol +” button and will decrease after pressing the “Vol –” button. When the volume is changed, the display will indicate the currently set level for two seconds, and after those two seconds, the routing will be displayed again.



## Configuration

Before the MWX45 wall panels can be used, the wall panels needs to be assigned to one particular zone. Perform the procedure described below to make sure this is done correctly.

Go to the “Setup” menu and click “System configuration”. Then click the “MWX45” button. A window with a drop down list will be shown, showing all the output zones from “Zone 1” to “Zone 8” (or “Zone 1” to “Zone 4” for MTX48). Select the zone where the wall panel should be assigned to, and click the “Set Address” button. The selected zone number will start blinking on the display of the wall panels, and after pressing the upper button on the desired wall panel, it will be assigned to the selected zone. Simply repeat this action until a zone is assigned for every connected wall panel.

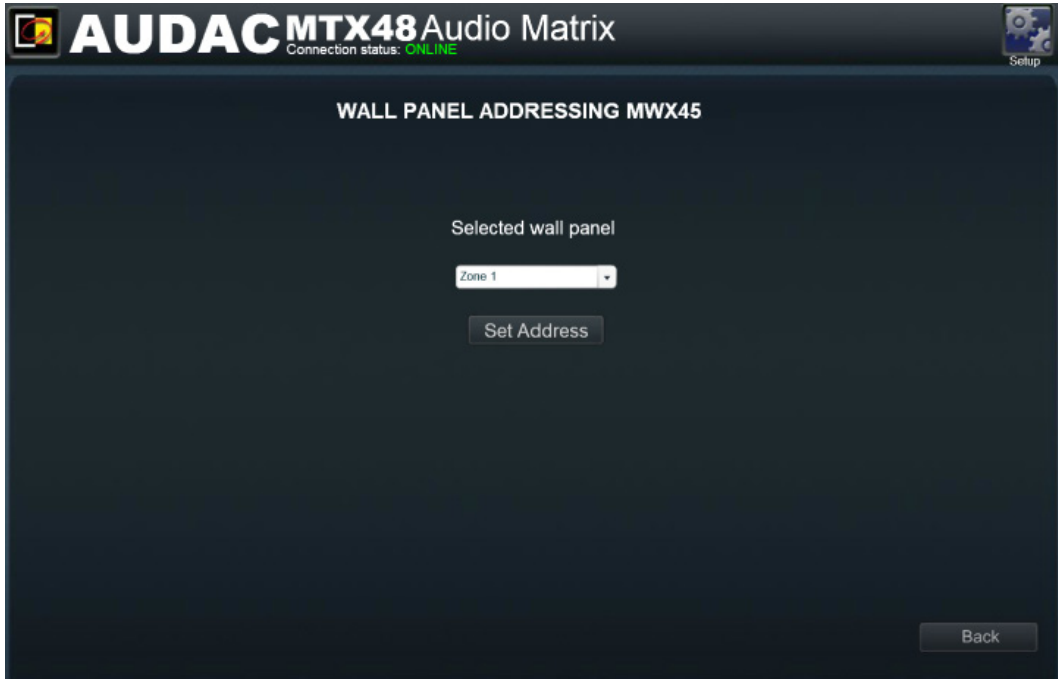

*MWX43/45 Settings screen*

## Maximum cable length

The maximum cable length depends of the number of connected wall panels. When only one wall panel is connected, a maximum cable length of 600 meters can be reached. The table below gives an overview of the maximum cable length, depending of the connected wall panels.

| No. of MWX43/45 Wall panels | Maximum cable length |
|-----------------------------|----------------------|
| 1                           | 600 meter            |
| 2                           | 600 meter            |
| 3                           | 400 meter            |
| 4                           | 300 meter            |
| 5                           | 200 meter            |
| 6                           | 150 meter            |
| 7                           | 120 meter            |
| 8                           | 100 meter            |

# MWX65 All-in-one wall panel

## Functions

The MWX65 is the most advanced All-in-one wall panel for the MTX. This wall panel has a graphics display and can control the routing, volume, bass, treble and mute for one zone. Besides those control functions, it also provides the possibility to connect a microphone and a stereo line input source. The MWX65 wall panel should be connected to the WP inputs of the MTX by using Cat5e (or better) cable.

The following functions of multiple zones of the MTX can be controlled:

- Volume within a range of  $-70$  dB to  $0$  dB
- All inputs can be selected
- Mute can be activated
- Bass within a range from  $-14$  dB to  $+14$  dB
- Treble within a range from  $-14$  dB to  $+14$  dB

## Configuration

Before the MWX65 can operate, the configuration should be made. First of all, an address need to be assigned and the available inputs need to be defined.

Follow these steps to configure:

1) Go to the “Setup” menu and click “System configuration”. To configure the settings for the MWX65 wall panels, click the corresponding button. After this button is clicked, a window will be shown where all the configuration settings for the MWX65 can be made. On the left side, a drop down list is shown whereby the address for the MWX65 can be selected. The address can be selected between “W001” to “W008”. Logically is started with the address “W001” for the first wall panel and increases the address for every subsequent wall panel. After the desired address is selected, click the “Set Address” button and the display on the MWX65 will start blinking. Confirm the address of the wall panel by pushing the big rotary button on the wall panel and the selected address will be assigned to the wall panel.

2) The zone which should be controlled by this wall panel can be selected by the drop down list which is shown one position to the right.

3) The inputs which are selectable with the wall panel can be chosen in the “Selectable inputs” drop down list. After the inputs are clicked, they will appear in the listbox shown below. They can be removed again from this listbox by selecting them, and clicking the “Remove Input” button.

Those selectable inputs are not linked with the “Quick selection menu” like the inputs on the MWX43/45 are.

4) Certain actions such as Volume Change, Input change, Mute, Tone control and settings can be disabled from the wall panel by ticking the checkboxes.

5) The microphone input has the possibility to provide  $+12$ V phantom power for powering condenser microphones. The phantom power can be switched ON and OFF by clicking the “Enable Mic Phantom” checkbox. This setting can also be changed in the MWX65 settings menu. (If “Block settings menu” is not checked)

6) The Backlight level, screensaver and screensaver delay can be set by means of three drop down boxes. This setting can also be changed in the MWX65 settings menu. (If “Block settings menu” is not checked)

7) When the settings are made, press the “Save to Wallpanel” button and the settings will be send to the selected MWX65 wall panel.

Previously made settings can be retrieved from the wall panel by clicking the “Load from Wallpanel” button. Hereby, the settings which are stored in the wall panel will be displayed in this window, making it possible to make any changes to the current settings.



*MWX65 Settings screen*

### Maximum cable length for MWX65

The maximum cable length for the MWX65 wall panel is 300 meter.

## WMI and WLI wall input units

### Functions

The WLI and WMI units are wall input units which can be used as additional local inputs for the MTX. They can easily be plugged in to the wall panel (WP) inputs on the rear side of the MTX and no additional configuration settings have to be made. The wall panel inputs are only available as input for the zone where its connected to.

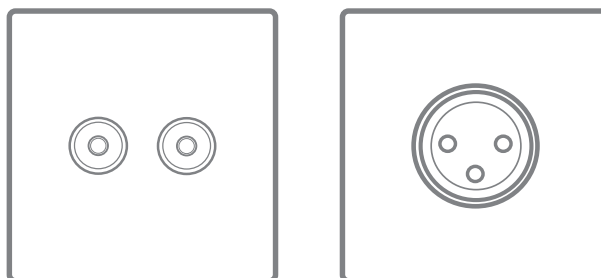

*WLI Line input (left) unit & WMI Microphone input unit (right)*

The Line input units (WLI) are equipped with an RCA connector which allows connection of any kind of Line Level audio source, such as CD–Player, MP3–Player, Computer, Laptop, ... The stereo signal is converted into a dual–mono signal and is transferred from the input unit to the MTX in an analogue differential way which is insensitive for noise or interference caused by external devices.

The Microphone input units (WMI) are equipped with a female XLR connector, whereto any kind of balanced microphone can be connected. For powering condenser microphones, 12 Volt phantom power can be enabled by a jumper on the rear side of the unit. The signal is transferred from the input unit to the MTX in an analogue differential way, which is insensitive for noise and interference caused by external devices.

The signal coming from the line input unit will be available on input 7 of the corresponding zone, and the signal coming from the microphone input unit will be available on input 8 of the corresponding zone. Two input units (one WLI and one WMI) can be connected in bus structure to one WP input. The inputs from the MWX65 and the inputs from the WLI are both available on input 7. This means that only one of these inputs can be connected at a time.

The connection of the WLI and WMI units should be done by using Cat5e (or better) cabling and the maximum cable length to the MTX is 300 meter.

## MTX Wall panel connection possibilities

This section provides an overview for the wall panel connection possibilities on the MTX. In reality there are many more combinations possible than described here, but with these few examples and the brief description it should be clear which connection solutions will work and which solutions won't work, and why.

*Multiple MWX45 Wall panels can be connected on one Wall Panel Input. They can be configured to control all the same, or different zones.*

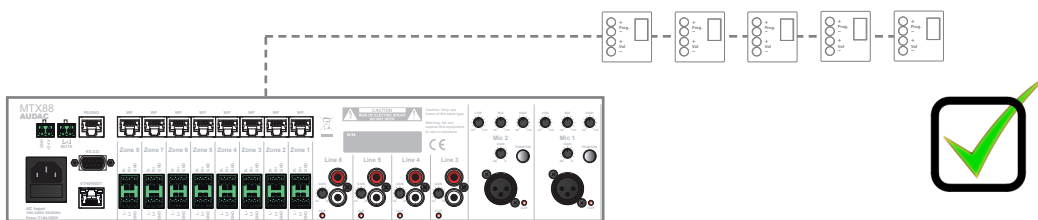

*Multiple MWX45 and one MWX65 Wall panel can be connected on one Wall Panel Input. They can be configured to control all the same, or different zones. The audio input of the MWX65 can only be routed to the zone its connected to.*

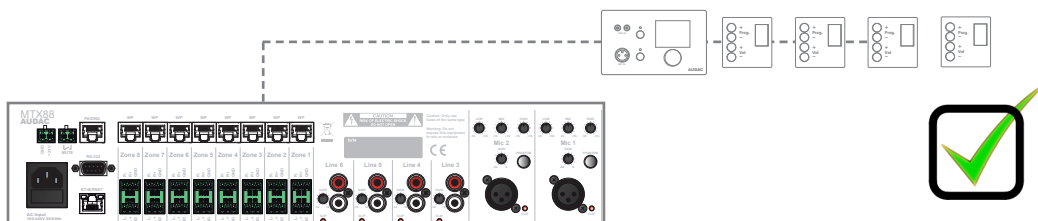

Multiple MWX65 Wall panel can be connected on one Wall Panel Input with one (or multiple) MWX45

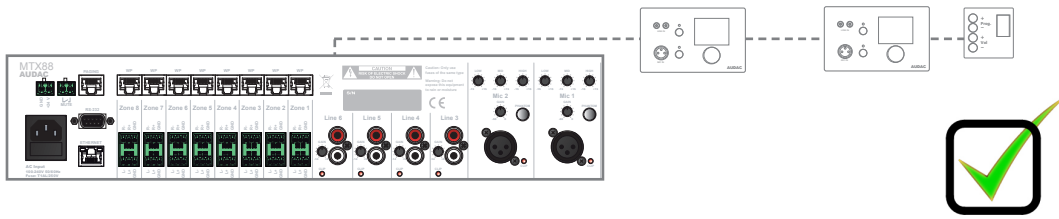

One Wall Line input (WLI) unit, one Wall Microphone input (WMI) unit and one (or multiple) MWX43/45 can be connected on one Wall Panel Input.

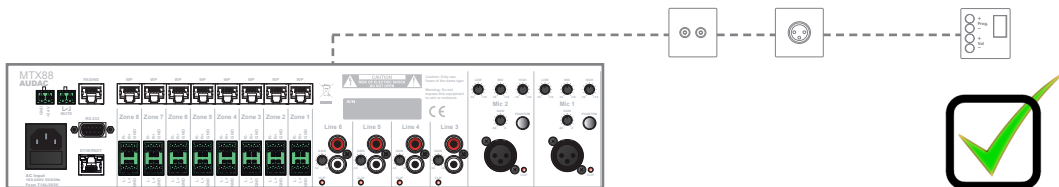

One Wall Microphone input (WMI) unit and one MWX65 Wall Panel can be connected on one Wall Panel Input. (The WMI audio input and MWX65 audio input are both using different pairs)

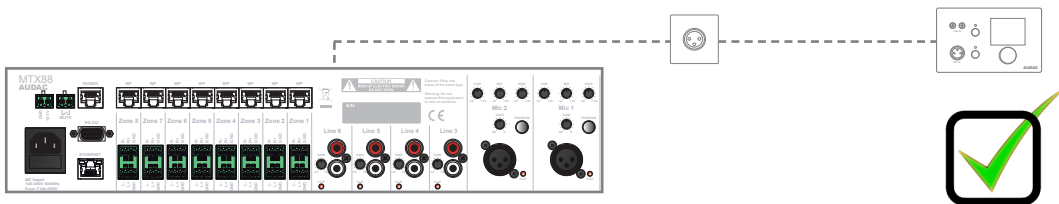

Multiple Wall Line input (WLI) units cannot be connected on one Wall Panel Input. (They use the same pair, both input 7)

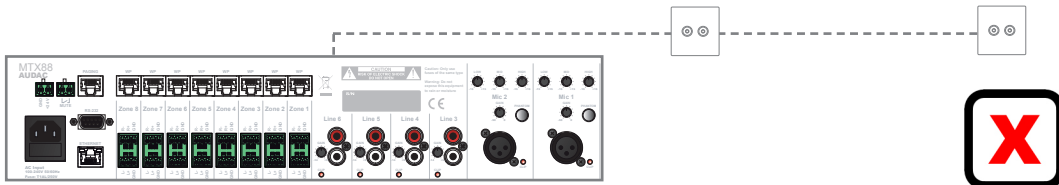

Multiple Wall Microphone input (WMI) units cannot be connected on one Wall Panel Input. (They use the same pair, both input 8)

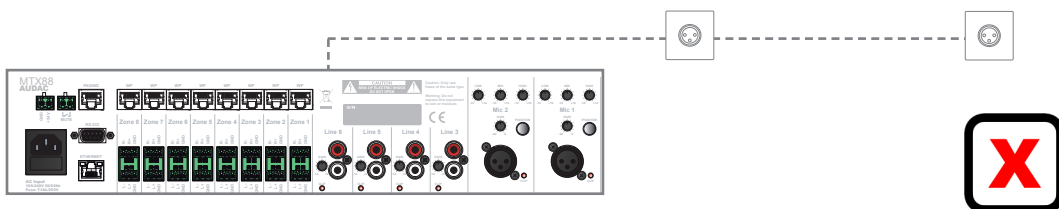

One Wall Microphone input (WMI), one Wall Line input (WLI) unit and one MWX65 Wall Panel cannot be connected on one Wall Panel Input. (The WLI and MWX65 user the same pair, both input 7)



# Paging

## Functions

The APM and MPX are optional paging systems which can be used for paging messages to the different zones of the MTX. These paging systems contain a base with different zone selection buttons. Depending of the number of zones (MTX48 or MTX88) associated paging consoles with 4 and 8 buttons are available. Using the buttons on the base of the paging consoles, zones can be selected whereto the paging announcements should be made.

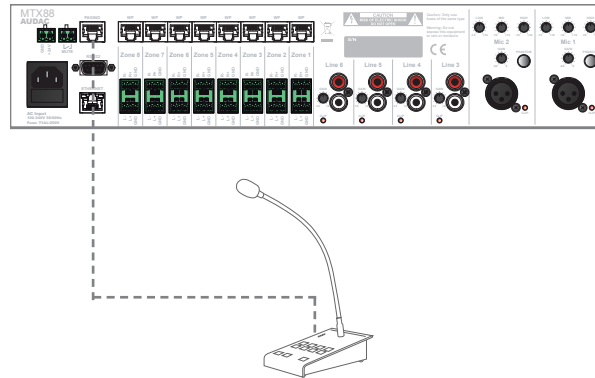

*Example of MTX Paging system with one paging console*

In contrast to the wall panel connectivity whereby no multiple identical units on the same databus may be connected, it is possible to connect multiple identical paging consoles on the 'PAGING' databus. When multiple paging consoles are connected in parallel on the 'PAGING' databus, the paging will become priority based. This means addresses must be assigned to every connected paging console.

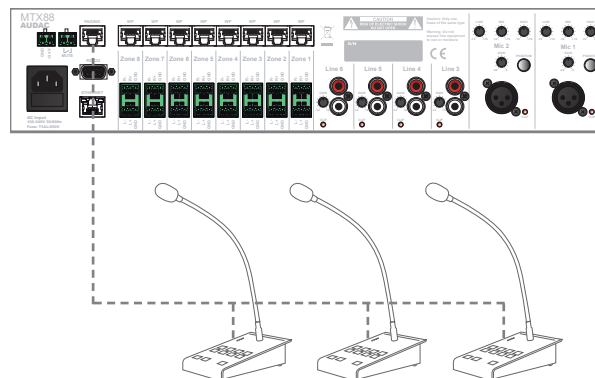

*Example of MTX Paging system with multiple paging consoles (Priority-based)*

## Configuration

To achieve a good operation of the paging system, some configuration settings have to be made. For configuration, the paging consoles should be connected to the 'PAGING' databus and the configuration should be done through the web-based user interface of the MTX. The paging configuration settings can be found in the "Setup" menu, under "System configuration" and then the third button "APM1xx". Follow the procedure below to make your paging system work successful.

The selected address is important to set the priorities when multiple paging consoles are linked in parallel. The paging console with the lowest address number (001) will have the highest priority in the system. When only one paging console is connected, it is recommended to always assign the address '001'. When multiple paging consoles are connected in parallel, the address '001' should be assigned to the paging console with

highest priority, and all other connected paging consoles should get increasing addresses in order of priority.

Select the address by the drop down box, and click the “Set Address” button. Now the lights on all the connected paging consoles will start blinking. After pushing the “PTT” (Push to Talk) button, the selected address will be assigned to the paging console which has been operated.

After the address has been assigned, the button “Configure APM” must be clicked when configuring APM paging systems, and all configuration data will be transferred and stored inside the paging console. MPX paging systems do not need extra handling after the address has been assigned.

Repeat this procedure for every connected paging console with different addresses in order of priority.

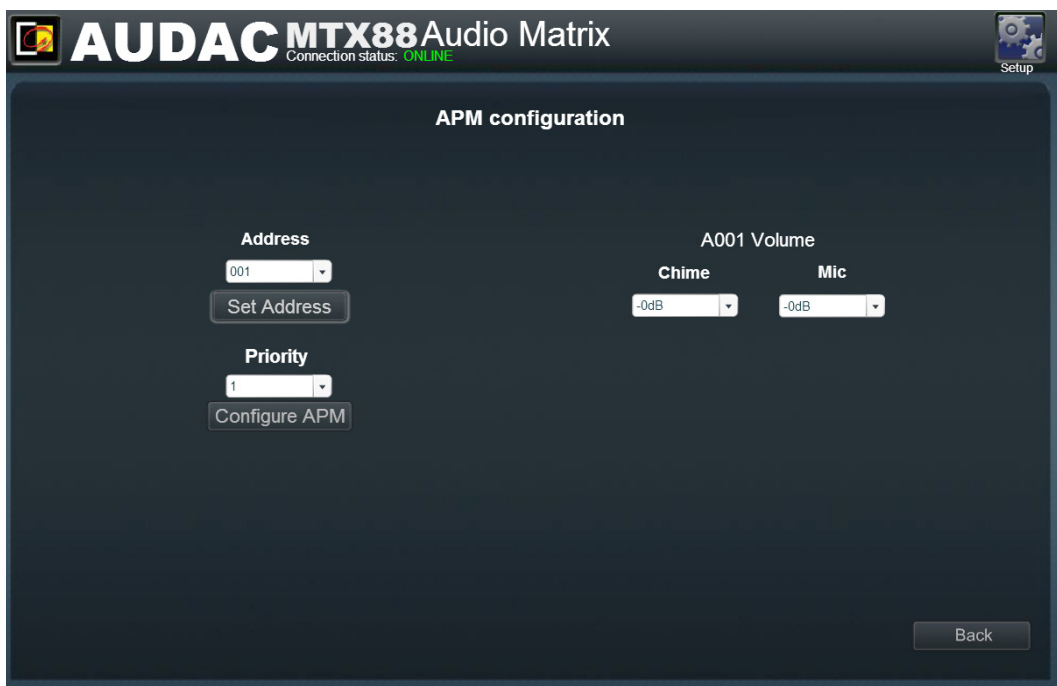

*APM Paging configuration screen*

On the right side of this screen, the ratio between the speech and chime signal can be set. When both speech and chime should be announced at maximum volume, both drop down lists should be set to ‘-0dB’. If the chime has to be announced louder than the speech or vice versa, this ratio can be adjusted by the drop down lists in a range between -0dB and -48 dB. The general paging volume for each zone (both chime and speech) will be dominated by the general paging volume settings, described later in this chapter.



MPX Paging configuration screen

### Paging volume

The paging volume for each individual zone can be set in the “Setup” menu under “Paging volume”. The volume can be set by means of the drop down boxes displayed next to the zone names. The paging volume can be set in steps of  $-1$  dB, starting by 0 dB, going to  $-\infty$ . When the volume is set to 0 dB, announcements for the corresponding zone will be made on maximum volume.



Paging volume setup screen



# Peripheral connection limits

The number of peripheral devices which can be connected to the MTX is depending of the current which should be delivered from the MTX side. Every peripheral device connected to the MTX has a certain power consumption which must be taken into account. The total current which should be delivered from the MTX side may never exceed the 1.5 Ampere limit. This includes the current for all wall panel inputs for every zone added with the current of the devices connected to the PAGING input. The table shown below gives an overview of the current consumption for every device which can be connected to the MTX.

| Peripheral device           | Current consumption |
|-----------------------------|---------------------|
| WLI Wall Line input         | 40 mA               |
| WMI Wall Microphone input   | 40 mA               |
| MWX43/45 Wall panel         | 14 mA               |
| MWX65 All In One Wall panel | 75 mA               |
| MPX48 Paging console        | 75 mA               |
| MPX88 Paging console        | 75 mA               |



## ATTENTION

Make sure the current consumption of all connected peripheral devices added together never exceeds the 1.5 Ampere limit

# Chapter 6

## Additional information

### IP Basics

Many AUDAC products are controllable by Ethernet. The Ethernet connection which is used on the AUDAC products is TCP/IP based, like 99% of the computer networks. There are some basics you need to know to successfully make a TCP/IP Ethernet connection.

The data in TCP/IP networks is always sent in packages, all these packages must be delivered at a unique address, just like the mailman delivers mail at your home mailbox. In TCP/IP networks, this address is called the “IP address”. The IP address is always a number in the following format “192.168.000.001”. As you can see, this address consists of 4 separate numbers ranging from “000” to “255”.

In simple terms, only the latest number of an IP address can be different within a network, so there is a maximum of 256 unique addresses within a network, ranging from “xxx.xxx.xxx.000” to “xxx.xxx.xxx.255”. The first three numbers must be the same to make communication between several devices possible, else the devices can not communicate with each other.

**Example:**

|           |             |                        |
|-----------|-------------|------------------------|
| Device 1: | IP address: | <b>192.168.000.001</b> |
| Device 2: | IP address: | <b>192.168.000.002</b> |
| Device 3: | IP address: | <b>192.168.001.003</b> |

In this example, Device 1 can communicate with Device 2, but not with Device 3, because the first three numbers must be the same. These first three parts are called the “IP range”, so the devices must be in the same “IP range” to communicate with each other.

The “IP range” of home and office networks are defined by the network administrator, this means that the IP range of your home or office network can be different from another network.

AUDAC products have the following IP address as default: “192.168.0.xxx”, this means the standard IP range of AUDAC products is “192.168.000.xxx”. If your network is using a different IP range, the AUDAC products will not be accessible from your network. You can change the IP address of the AUDAC products to make them work properly in your network. This can be done in the settings menu, and is described extensively in the “Settings” chapter of this user manual.

Of course, to make changes to the settings menu of the AUDAC products, you must have access to the user interface on the products webpage. This can be done by temporarily giving your computer an IP address within the IP range of the AUDAC product, for example “192.168.0.200”. After the IP address of your computer is within the IP range of the product, the user interface is accessible and the IP address of the product can be changed to an IP address within the IP range of your network. If the IP address of the product is within the IP range of your network, you can change the IP address of your computer again to its former IP address and the product should work properly in your home or office network.

Ask your network administrator for help if you are not familiar with networks.

### Summary

- All devices must have a unique IP address
- All devices must be within the same IP range

## Updating the MTX

### TCP/IP

Updating of the MTX can be done by using the TCP/IP Protocol. Simply connect the MTX to your LAN network and both updates for firmware and website can be done from every computer connected in your LAN network.

### ASM

Actual updating your MTX is done using the ASM (Audac System Manager) which is a windows compatible software application, detecting all 'smart' devices in your system, and allows the update and configuration of them.

For more information on the Audac System Manager, and the latest updates, please visit our website @ [www.audac.eu](http://www.audac.eu) als search for ASM.

# Technical specifications

|                     |                             |                       |   |
|---------------------|-----------------------------|-----------------------|---|
| Inputs              | Balanced Microphone         | Type                  | 2 x Balanced Microphone   |
|                     |                             | Connector             | XLR   |
|                     |                             | Sensitivity (1W/1m)   | 0 dBV ~ 50 dBV  |
|                     |                             | Phantom Power         | 15 V DC   |
|                     |                             | Signal / Noise        | > 80 dB   |
|                     |                             | THD+N (@ 1 kHz)       | < 0.05 dB   |
|                     |                             | EQ                    | High ± 15 dB (12.5 kHz)<br>Mid ± 15 dB (2.5 kHz)<br>Low ± 15 dB (80 Hz) |
|                     | Unbalanced Stereo           | Type                  | 4 x Stereo Unbalanced Line  |
|                     |                             | Connector             | RCA   |
|                     |                             | Sensitivity (1W/1m)   | -14 dB ~ +9 dB  |
|                     |                             | Signal / Noise        | > 100 dB  |
|                     |                             | THD+N (@ 1 kHz)       | < 0.01 dB   |
|                     |                             | Wall Panel            | Type<br>Connector   |
| Other               | Type                        | Priority mute contact |   |
| Outputs             | Balanced Stereo             | Type                  | 3-pin Euro Terminal Block (Pitch – 3.81 mm)                             |
|                     |                             | Impedance             | 51 Ω  |
|                     | Level                       |                       | -70 dB ~ 0 dB   |
|                     | EQ                          | Treble                | ± 14 dB (2.5~20 kHz)  |
|                     |                             | Bass                  | ± 14 dB (100 Hz)  |
|                     | Frequency Response (± 3 dB) |                       | 20 Hz – 20 kHz  |
| Crosstalk (@ 1 kHz) |                             | -85 dB                |   |
| Control             |                             |                       | Front panel   |
|                     |                             |                       | RS-232  |
|                     |                             |                       | TCP/IP (RJ45)   |
|                     |                             |                       | Wall panel (RS-485)   |
|                     |                             |                       | Audac Touch™  |
|                     |                             |                       | Web (HTML5)   |
|                     |                             |                       | Web (Flash)   |
| Power               | Consumption                 |                       | 12 W  |
|                     | Supply                      |                       | 100 ~ 240 V AC / 50 ~ 60 Hz   |
|                     |                             |                       | 24 VDC (emergency Power)  |
| Dimensions          |                             |                       | 482 x 88 x 335 mm (W x H x D)   |
| Weight              |                             |                       | 4.750 kg  |
| Unit height         |                             |                       | 2 HE  |





