

XMP44

User Manual



www.audac.eu

ADDITIONAL INFORMATION

This manual is put together with much care, and is as complete as could be on the publication date. However, updates on the specifications, functionality or software may have occurred since publication. To obtain the latest instruction manual or obtain additional product information, please visit the product page on www.audac.eu. For information about software version updates, please visit www.audac.eu/software.

Index

Introduction	5
Precautions	5
Safety requirements	6
Caution servicing	6
EC Declaration of Conformity	6
Waste of Electrical and Electronic Equipment (WEEE)	7
Caution	7
Chapter 1: Pin connections and connectors	8
Connection standards	8
Chapter 2: Front & rear panel	10
Front panel overview	10
Front panel description	10
Rear panel overview	11
Rear panel description	11
Chapter 3: User interface & control	12
Front panel control	12
Main	13
Module	13
Module settings	14
General settings	15
Network settings	16
Web-control interface	17
Login	17
Main	17
Module	19
Settings	19
Chapter 4: Installing the modules	21
Chapter 5: Additional information	23
IP Basics	23
Technical specifications	24
Notes	25

Introduction

SourceCon™ Professional modular audio system

The XMP44 is a professional modular audio system with 4 SourceCon™ interface card slots where to a wide variation of optional modules can be installed. The variety of available modules ranges from FM tuners to DAB&DAB+ tuners, internet radio tuners, voice file interfaces and many more.

The flexible architecture allows any project combination up to four sources, resulting in a truly versatile solution that will live up the needs for any user taking high regard of crystal clear audio reproduction. Simultaneous operation for all four modules makes it a compact multi-source system which is the perfect expansion for any multi-zone audio system.

The front panel of the system accommodates a 2.8" TFT display in combination with a push rotary function dial and 4 tactile pushbuttons. The controls and indicators on the front panel of the unit are guaranteeing an intuitive and user friendly operation, allowing hassle free operation and configuration to even unexperienced users. Four USB interfaces (one for each module) are enabling playback or storage of media and voice file, while pre-listening for each output is possible through a built-in PFL speaker with individual volume control.

Both RS-232 and TCP/IP communication ports are implemented, allowing system integration with any home or industrial automation system. Using the freely available Audac Touch™ application for smart devices guarantees total system control and configuration from any device on any location and at any time.

POWER SUPPLY AND POWER CORD REQUIREMENTS

Power supply class I grounding requirements:

For protection from fault currents, the equipment shall be connected to a grounding terminal. Plug the system power cord into an AC outlet that provides a ground connection. Substitute cords may not provide adequate fault protection. Only use the power cord supplied with this product or an authorized/equivalent replacement

Safety notices:

Denmark:

Apparatets stikprop skal tilsluttes en stikkontakt med jord, som giver forbindelse til stikproppens jord.

Finland:

Laite on liitettävä suojakoskettimilla varustettuun pistorasiaan.

Norway:

Apparatet må tilkoples jordet stikkontakt.

Sweden:

Apparaten skall anslutas till jordat uttag.

ATTENTION

The fuse (T500mAL/250V) provides a safeguard function to the device. When replacing the fuse, make sure that the value of the replacement matches the value of the original fuse. Identification of a suitable replacement component or substitute shall be done by qualified technicians.

Precautions

READ FOLLOWING INSTRUCTIONS FOR YOUR OWN SAFETY

ALWAYS KEEP THESE INSTRUCTIONS. NEVER THROW THEM AWAY

ALWAYS HANDLE THIS UNIT WITH CARE

HEED ALL WARNINGS

FOLLOW ALL INSTRUCTIONS

NEVER EXPOSE THIS EQUIPMENT TO RAIN, MOISTURE, ANY DRIPPING OR SPLASHING LIQUID. AND NEVER PLACE AN OBJECT FILLED WITH LIQUID ON TOP OF THIS DEVICE.

DO NOT PLACE THIS UNIT IN AN ENCLOSED ENVIRONMENT SUCH AS A BOOKSHELF OR CLOSET. ENSURE THERE IS ADEQUATE VENTILATION TO COOL THE UNIT. DO NOT BLOCK THE VENTILATION OPENINGS.

DO NOT STICK ANY OBJECTS THROUGH THE VENTILATION OPENINGS.

DO NOT INSTALL THIS UNIT NEAR ANY HEAT SOURCES SUCH AS RADIATORS OR OTHER APPARATUS THAT PRODUCE HEAT

DO NOT PLACE THIS UNIT IN ENVIRONMENTS WHICH CONTAIN HIGH LEVELS OF DUST, HEAT, MOISTURE OR VIBRATION

THIS UNIT IS DEVELOPED FOR INDOOR USE ONLY. DO NOT USE IT OUTDOORS

PLACE THE UNIT ON A STABLE BASE OR MOUNT IT IN A STABLE RACK

ONLY USE ATTACHMENTS & ACCESSORIES SPECIFIED BY THE MANUFACTURER

UNPLUG THIS APPARATUS DURING LIGHTNING STORMS OR WHEN UNUSED FOR LONG PERIODS OF TIME

ONLY CONNECT THIS UNIT TO A MAINS SOCKET OUTLET WITH PROTECTIVE EARTHING CONNECTION



WASTE ELECTRICAL AND ELECTRONIC EQUIPMENT (WEEE)

The WEEE marking indicates that this product should not be disposed with regular household waste at the end of its life cycle. This regulation is created to prevent any possible harm to the environment or human health.

This product is developed and manufactured with high quality materials and components which can be recycled and/or reused. Please dispose this product at your local collection point or recycling centre for electrical and electronic waste. This will make sure that it will be recycled on an environmentally friendly manner, and will help to protect the environment in which we all live.



CAUTION

The symbols shown are internationally recognized symbols that warn about potential hazards of electrical products. The lightning flash with arrow point in an equilateral triangle means that the unit contains dangerous voltages. The exclamation point in an equilateral triangle indicates that it is necessary for the user to refer to the users manual.



These symbols warn that there are no user serviceable parts inside the unit. Do not open the unit. Do not attempt to service the unit yourself. Refer all servicing to qualified personnel. Opening the chassis for any reason will void the manufacturer's warranty. Do not get the unit wet. If liquid is spilled on the unit, shut it off immediately and take it to a dealer for service. Disconnect the unit during storms to prevent damage.

Chapter 1

Pin connections and connectors

CONNECTION STANDARDS

The in- and output connections for AUDAC audio equipment are performed corresponding to international wiring standards for professional audio equipment.

3-Pin Terminal Block:

For balanced signal input & link output connections.

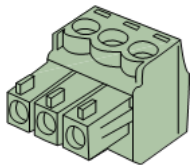

Left: Signal – (XLR Pin 3)
Center: Signal + (XLR Pin 2)
Right: Ground (XLR Pin 1)

For balanced line input connections

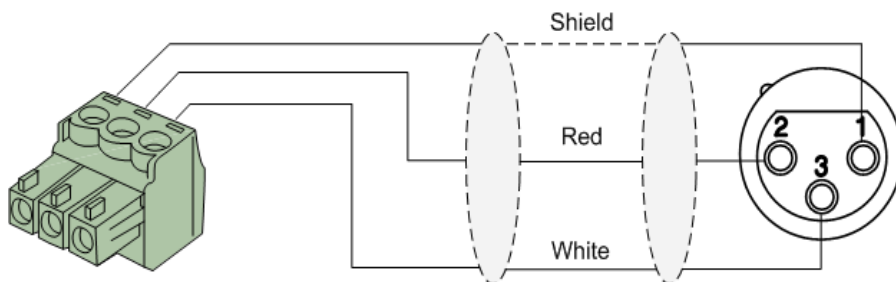

For balanced line output connections:

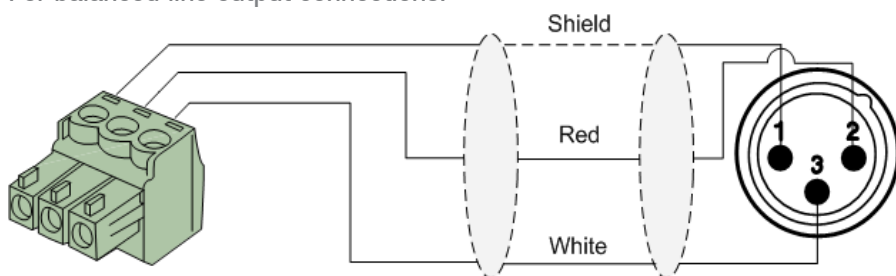

For unbalanced line in & output connections:

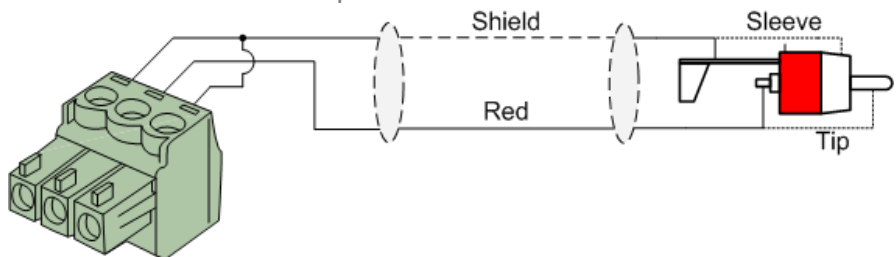

RS232 (serial connection interface):

For connection with home automation systems, or other remote control equipment

Connection	Standard RS232
PIN 2	XMP44 TX
PIN 3	XMP44 RX
PIN 5	GND
Settings	19200 Baud 8 Bit 1 Stop bit No parity No Handshaking

RS232

The XMP44 has an RS232 and TCP/IP ports accepting the same commands. The complete command set to control the XMP44 is available in the XMP44 commands user manual which is freely downloadable on www.audac.eu

Chapter 2

Front & rear panel

Front Panel overview



Front panel description

PFL Loudspeaker with volume dial:

The built-in PFL loudspeaker allows pre-listening of the outputs of the installed audio modules without requiring headphones or other tools. The currently enabled audio module (displayed on the graphical display) will be heard through the PFL speaker. The level of the PFL loudspeaker can be controlled using the potentiometer located below.

USB Ports (4x):

A USB port for each module slot (4x) is located on the left side of the front panel. Each USB port is internally connected with the corresponding module slot and can be used (when USB functions are supported) for data storage, media playback or any other supported function. The upper USB port (indicated with 'Update') supports some extended functionality. Each USB port is accompanied with a green LED, which indicates whether USB functionality is supported for the installed module.

Graphical LCD display with tactile push buttons and rotary selection dial:

A clear system overview and intuitive user experience is offered using the 2.8" graphical LCD display accompanied with four tactile selection buttons (left side) and a rotary selection dial (right side). The true colour display offers a clear overview of the systems current operation mode with intuitive and user friendly browsing through the menu structure.

The functionality of the four push buttons depends on the current operation mode and position in the menu structure. In the main menu, four buttons will be linked with four different module slots allowing to enter their specific menu and offering access to its further functions. In other menu's, corresponding icons are shown on the left side of the display.

Parameter adjustment and browsing is made easy using the rotary function dial. This multifunctional dial allows easy one-hand operation throughout the entire menu structure. Browsing through the menu is done by rotating it while actions are made by pressing it.

Power switch:

Allows to power the system ON and OFF. The blue indicator LED illuminates when switched on.

Rear Panel overview



Rear panel description

AC Power inlet with fuse:

The mains power supply (100–240V AC – 50/60 Hz) has to be applied to this AC power inlet. The connection is made by an IEC C14 power connector and is fitted with a fuse. When replacing the fuse, make sure that the value of the replacement fuse matches the value of the original fuse. (T0.5AL/250V)

RS232 Connection:

The RS232 connection can be used to control the system and its installed modules through any external hardware such as home and industrial automation systems. The pinout and communication settings are described in an earlier chapter of this user manual. The complete RS232 command instruction set and configuration information can be downloaded from the AUDAC website.

Ethernet RJ45 Connector:

The connection to any LAN network is possible using the RJ45 ethernet connection. This allows control of the system and its installed modules from any ethernet supported device. Various possibilities of ethernet control are available, including sending commands over TCP/IP, controlling the system through the integrated web–interface, or full system control using the Audac Touch™ application.

For more information about the Ethernet configuration of this device, check ‘Chapter 4: User interface & Configuration’ and ‘Chapter 6: IP Basics’ of this user manual.

SourceCon™ interface card slots:

Four modular slots are available on the rear panel of the unit, allowing installation for a wide variation of optional SourceCon™ modules depending of the required system functionality. The module slots are fitted with a guiding system and connections are made by board–edge connectors allowing fast and simple installation. Once installed, functionalities are automatically discovered at startup and made operational by the device software.

Chapter 3

User interface & configuration

The XMP44 contains a variation of control and configuration possibilities. The front panel of the unit is fitted with a 2.8" graphical display unit, allowing instant control and configuration possibilities through an intuitive and user friendly user interface.

Besides, its functions can be remotely controlled through the embedded web–control interface. This fully adaptive interface based on HTML5 technology can be accessed from any websocket supporting device, offering cross–platform compatibility with Windows, Mac OS, Linux, Android and iOS without requiring any installed applications or web plugins. The fully adaptive structure guarantees a clear viewing on all different kinds of screen sizes.

When application specific or total system control is required, the XMP44 can be controlled using the Audac Touch™ application. This application allows to custom configure your control panel (Dashboard) according to project or user specific requirements.

For using the remote web–control or Audac–Touch interface, the XMP44 shall be connected to an ethernet LAN network and accessed by its IP address. The standard (factory default) IP address of the XMP44 is 192.168.0.196, make sure this address is within the IP range of the connected ethernet LAN network (subnetmask 255.255.255.0). If the default network address is not within range of your LAN network, it can be changed in the settings menu, using the front panel interface.

Front panel control

The front panel controllable functions are strongly depending of the installed module and its functionalities. Therefore, it is not possible to describe the menu structure possibilities for each individual module in detail. An overview of how the entire menu is constructed and how to navigate through it is given here.



The front panel of the device includes a 2.8" graphical LCD display, which is accompanied with four tactile push buttons (left side) and a rotary selection dial (right side). This combination allows you to navigate through the systems user interface and access all the available control and configuration possibilities of the system.

The functionality of the four tactile push buttons on the left side depends on the current mode and position in the menu structure. In the main menu, these buttons will be linked with four different module slots allowing to enter their specific menu and offering access to its further functions. In the control menus (not configuration) there will always be 4 icons shown on the left side of the display which functionalities are linked with the corresponding buttons.

The rotary selection dial can be used for parameter adjustments and browsing to station lists, playlists or any other. This multifunctional dial allows easy one–hand operation throughout the entire menu structure. Browsing is done by rotating it while actions are made by pressing it.

Front control >> Main

When powering–on the system, the main screen of the user interface will be displayed giving an overview of all installed modules among each other.

When any module installed, an icon will indicate the functionality of the module on the left side. Depending on different functionalities, different icons will be shown. If no module installed, the provided area will stay blank.

When any module installed and playing, the information regarding the playing station, track, tuning frequency or any other carried information will be indicated at the center of the provided information.

Additional information will be indicated by icons on the right side of the provided area. Few typical examples are FM and or DAB/DAB+ symbols, indicating the kind of received signal, percentage numbers indicating the strength of the received signals, ... and so on.



Front control >> Module









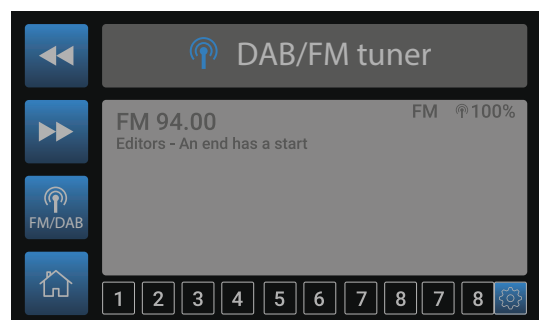
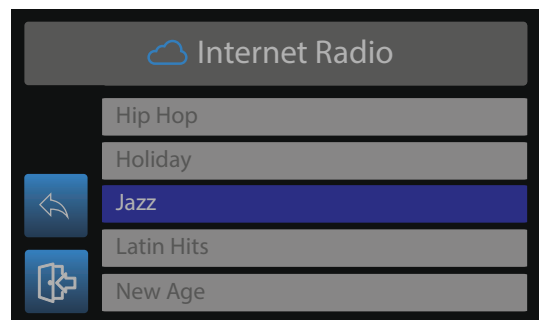
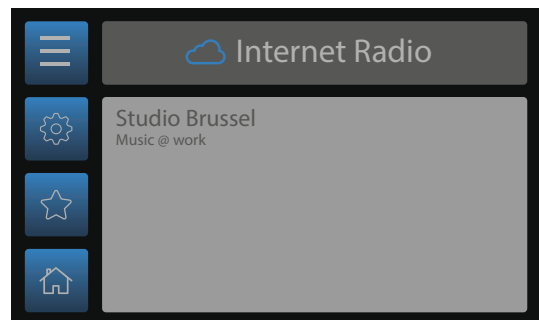



When the module to be operated has been selected, the control screen for the corresponding module will be loaded. As earlier indicated in this manual, the available functions and construction of this screen depends of the installed module and its functionality. In this chapter, the basic functions and structure is indicated allowing you to understand and use any type of control screen for any type of module.

The left side of each control screen contains four icons, linked with the tactile push buttons on the side of the screen. The corresponding menu will be loaded once the button is pressed.

Some typical control screens (e.g. tuner control screens) are having a horizontal array of numbers on the bottom of the screen (see the bottom screen–shot on this page). This horizontal array is representing 10 positions whereto presets can be saved. Navigation between these presets is possible by turning the rotary dial, and the current selection can be stored to the preset position by selecting it and pressing the save button.

The functionality for each icon is indicated in the table on the next page.



ICON	DESCRIPTION
	Show track list / station list
	Go to module settings
	Mark / save current selection as favorite
	Go to general settings
	Go back to system main screen
	Go back to module screen
	Go one step back
	Previous track / station
	Next track / station
	Play / Pause
	Erase current selection
	Mark / save current selection as favorite
	Switch between FM / DAB functionality

Front control >> Module settings

Each of the modules has a module settings screen. This settings screen can be accessed by clicking the  in the control screen.

Depending on the installed module, the available module settings will be different. For a full overview of the available settings for the corresponding module, refer to the instruction manual of the installed module.

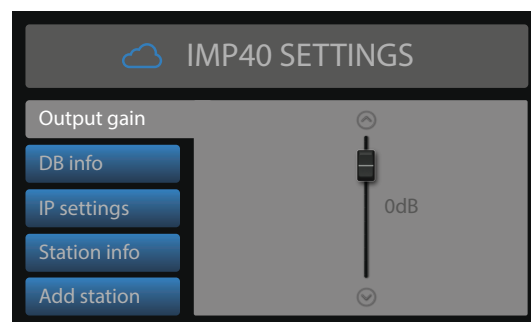

Front control >> General settings

The general settings screen can be accessed by pressing the rotary dial when viewing the main screen. The general settings menu allows to configure all the global settings for the XMP44 unit, keeping aside the settings and functionalities of the installed modules. The functionalities of the general settings menu are described as follows:

Lock:

When selecting 'Lock', the system will be locked and will require a password to be entered before any further action can be taken (if the password is enabled).

Info:

Info will give an overview of the XMP44 device, the software version it (XMP44) is running, the types of installed modules and the software versions the modules are running.

LCD Settings:

Adjustments for the LCD settings can be made here. The brightness can be adjusted within a range of 10% to 100% (standard is 80%). Adjusting of the LCD brightness can be convenient when the device is placed in an environment with very low or very high ambient light. Hereby the clarity of the LCD can be adjusted being clear but unobtrusive.

The backlight off time can be adjusted within an interval of 10 up to 120 minutes or never (always on), making the backlight of the LCD automatically turn off after the set time.

Password:

Password protection can be enabled, avoiding unauthorized users to make any adjustment to the system. The password is a four-digit code. In default, the password is set to '0000' which gives full access to the system without requiring any password to be entered. If the configured password is different from '0000', the user will be requested to enter the password before any access to the systems functions is provided.

The configuration of the selected password can be made by selecting it in the general settings menu. The currently set password will be shown and the adjusting digit can be selected (turns red) and confirmed by turning and pressing the rotary selection dial. Consecutive digits will increase when the maximum value has been reached.

After the desired password has been selected it can be confirmed by pressing (turns red) and turning the function dial clockwise to the entire right side where the 'OK' word will appear. After pressing again the password is confirmed.

USB:

The USB function allows to switch the upper USB (indicated as 'UPDATE') between Module 1 and main XMP44 functionality. In standard the configuration, it is connected to 'Module 1', allowing functionality for USB supporting modules such as media players. In case any general system functionalities are required such as system updates, this USB slot should be connected to the XMP44. Toggling between Module 1 and main XMP44 functionality is done by pressing the rotary dial.

Time server:

When any module is installed which supports timed events (eg voice file player for announcements at pre-programmed moments), the XMP44 shall get time synchronization from a time server. In default configuration, an internet timeserver is being used which always guarantees an accurate synchronization of the system according to GMT. Depending of the time zone and/or location, the GMT offset settings have to be made accordingly.

In case your system is restricted from access to internet, an internal time server on your LAN network should get assigned offering synchronization to the system. The IP address of the internal time server should be entered by toggling from 'Use internet timeserver' to 'Manually set timeserver IP'. The procedure of entering a timeserver IP is identical to standard IP settings, which are described in the 'IP settings' chapter of this instruction manual.

Front control >> Network settings

When the Network settings button is highlighted, an overview of the currently configured network settings is given on the right screen side. When selected, a separate IP settings menu will be loaded, where all network settings can be customized.

DEFAULT NETWORK SETTINGS
DHCP: OFF
IP address: 192.168.0.196
Subnet mask: 255.255.255.0
Gateway: 192.168.0.253
DNS 1: 8.8.4.4
DNS 2: 8.8.8.8

DHCP:

When DHCP is enabled, the IP address for the XMP44 will be automatically assigned by the DHCP server in your network. It is not always recommended to use this option, since then the IP address of the system will not always be known for the user and might be different after system reboot.

IP address:

The IP address for the system can be configured in this window. Each section of the IP address can be individually adjusted by turning the rotary dial (clockwise for up, and counter-clockwise for down). The currently adjusting section will be indicated in blue colour. Once the correct number for the current section is selected, proceed to the next section by pressing the rotary dial.

Network settings:

All other network settings such as subnet mask, Gateway, DNS 1 and DNS 2 can be configured in this window. The default settings are configured in such way to suit most typical installations requirements. In case of special network restrictions or requirements, consult your network administrator for more details on the network settings.

All additional network settings can be modified in similar way as the IP address, allowing adjustments by turning and pressing of the rotary dial.

SAVE
Any changes to network settings made in this menu shall be saved by selecting 'Apply settings' through highlighting and pressing it. Otherwise the made changes to the settings won't be applied to the system.

Web–control interface

Start your default web browser and enter the IP address of the embedded web–control interface in the address bar (The factory default IP address is <http://192.168.0.196>)

Web–control >> Login

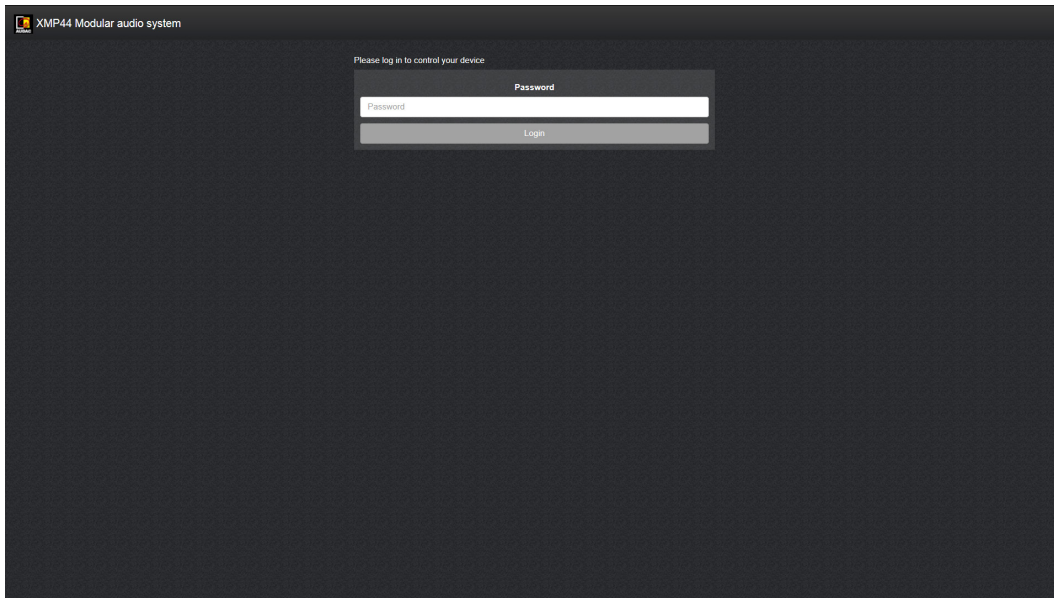

When accessing the web–control interface of the XMP44, a password should get entered to control the functions of the system. Two different levels are possible for **administrator** and **user** access.

When logging in using the administrator password, full access is given to all systems functions and configuration possibilities. (The factory default password for administrator access is 'XMP') When logging in using the user password, restricted access for only the basic functions of the system is given, allowing system control and operation without authorization for making any changes to the system configuration. (The factory default password for user access is 'user')

After the right password is entered, press the 'OK' button, and you will be redirected to the main screen of the web–control interface.

NOTE

If application specific limitations or restrictions for certain functions are required, the system control can be done through the Audac Touch™ freely available application, which allows you to create customized control dashboards.

Web control >> Main

The main screen gives a total overview of the system and the installed modules.

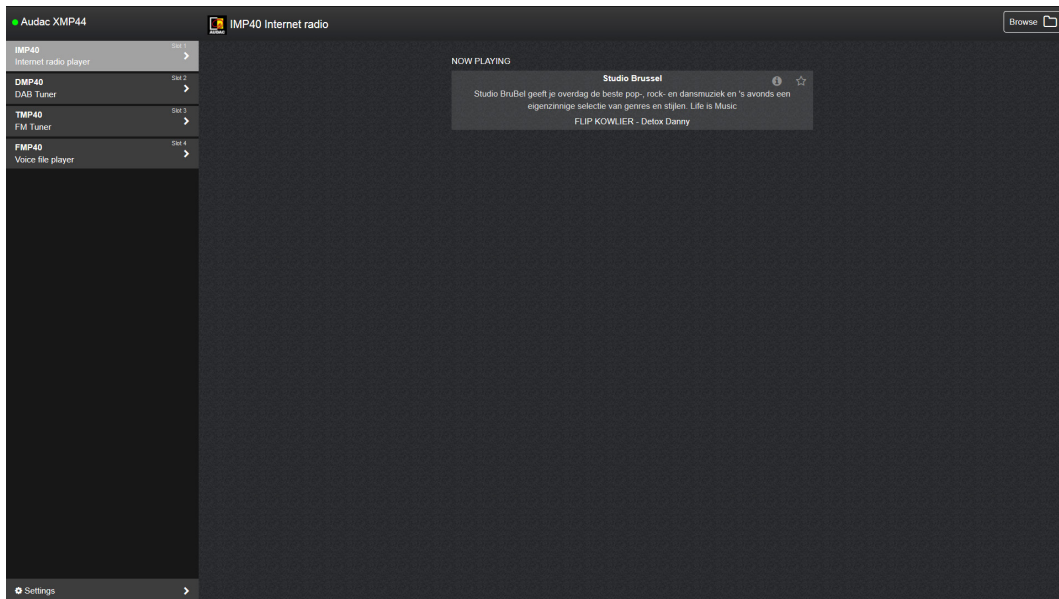

Modules overview:

The left side shows a modules overview column indicating the different installed modules among each. Depending on the number of installed modules, a maximum of 4 different module selectors will be shown. When a slot is left empty, the corresponding slot will be hidden from this list.

The installed modules are indicated with the module type and a short description of the modules function. When the module name is clicked, the operation menu for the corresponding module will be loaded and indicated on the center area of the screen.

Settings:

At the bottom of the modules overview column, a 'Settings' button is indicated. This button links to the XMP44 settings menu, which includes all General XMP44 settings, including the settings for the installed modules. More details about the configurable settings are described later in this instruction manual.

Functions overview:

The main area of the screen includes a functions overview window, indicating the various module functionalities, indicators and controls. The displayed items will depend on the functionalities of the installed modules. Media players or tuners will give an indication of the currently playing track or station including additionally carried information (RDS or RadioText for tuners, ID3 and album cover information for media players)

Web control >> Modules

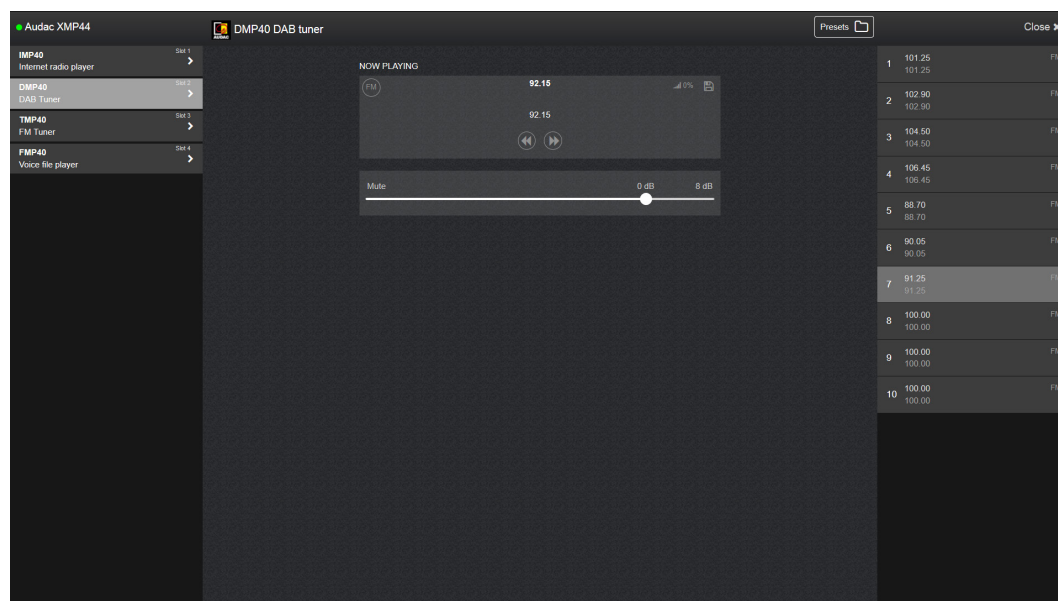

The modules screen gives an overview of the controllable functions for the currently selected module. The currently selected / controlling module is highlighted in the left side column and the main area (center) of the screen indicates the current operation mode, depending on the offered functionalities for the installed module.

Some typically displayed functions are the currently playing radio station, including additionally carried information such as station name, track name, ... and many more. Some basic available functions for track and/or radio station selection will also be shown in the main area (center) of this screen.

When the installed module supports advanced browsing functionalities (e.g. internet radio player which supports browsing on Genre, Location, ...) a 'Browse' icon will be displayed in the top right corner of this screen. When clicking this icon, a detailed overview of the available browsing functionalities is given. Browsing through this menu is possible by clicking and scrolling through this menu structure.

Web control >> Settings

The settings screen includes all configurable settings which can be made to the XMP44 and its installed modules. This interface is constructed as an accordion type menu structure with various subdivisions for the general settings and module settings. General settings are displayed on top while module settings are displayed below.

Switching between the settings is done by clicking the corresponding title bar, and subsequently the selected settings will be shown while others are hidden.

For making any adjustments to the displayed settings, click the 'Edit' icon on the right side of the screen, and a pop-up window allows adjustment of the currently selected parameters.

Settings can be made / adjusted using slide bars (horizontal), drop-down boxes, text fields or toggle switches.

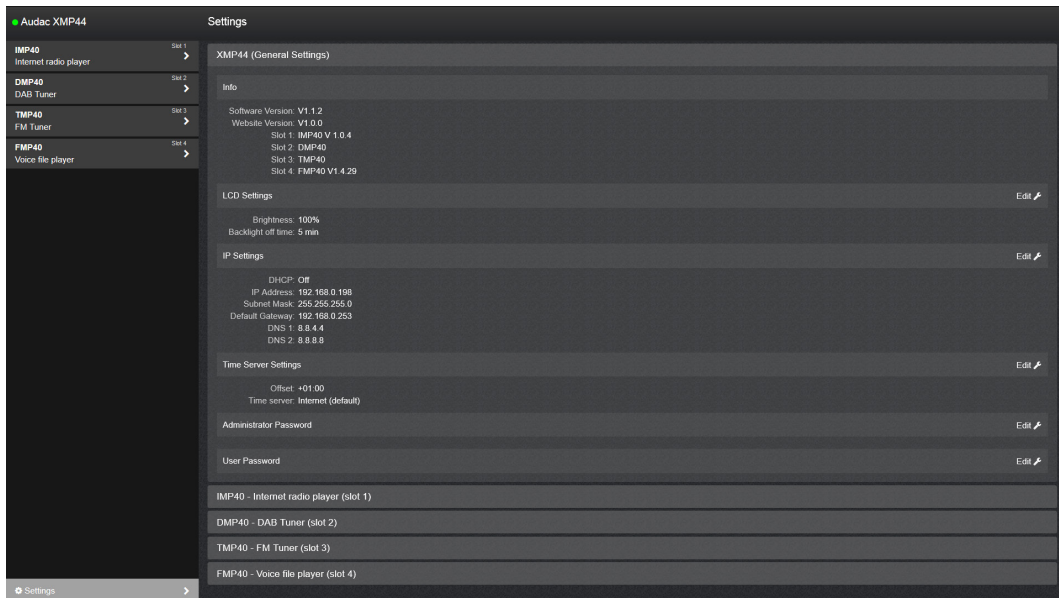

General settings:

The general settings menu gives an overview of the currently running software version and installed modules with their firmware versions. All 'General' settings configurable through the front panel interface can also be adjusted here.

Module settings:

The configurable module settings are depending on the model / functionalities of the installed modules. For a full overview of the available settings for the corresponding module, refer to the instruction manual of the installed module.

Chapter 4

Installing the modules

CAUTION



Before installing any modules to the expansion slots of the XMP44, make sure the XMP44 power is switched off. Malfunctions or electrical shocks may occur otherwise.

Step 1:

Make sure that all slots where modules shall be installed are open and ready for installation. In standard (factory default) configuration, the XMP44 comes delivered with slot 4 open and slots 1 to 3 covered by a blind panel. Depending on the requested number of installed modules, the corresponding blind panels should be removed by releasing the screws on both ends.

Step 2:

Before removing the modules from their protective bag, we recommend touching the grounded metal chassis of the XMP44 (or any other grounded point) to prevent electrostatic discharges affecting the sensitive electronic components. It is recommended to always hold the module card by the metal connection panel and avoid touching of the components on the circuit board directly.

Step 3:

Align both edges of the module with the guide rails inside the slot and carefully insert the module into the slot. It should slide into the slot without any considerable resistance when well positioned into the guide rail.

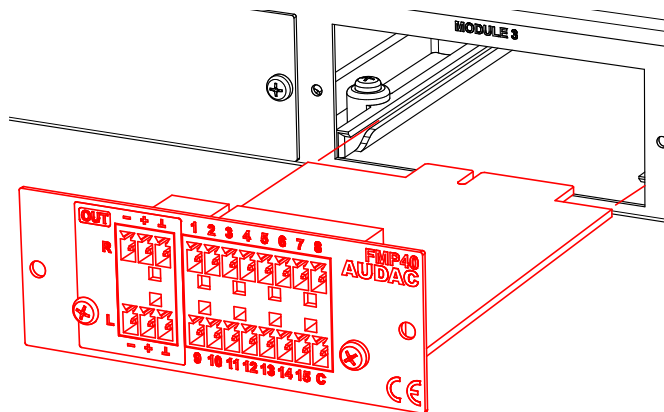

Step 4:

Some resistance might occur when the module's board edge connector reaches the connection counterpart on the main board. Gently push the module all the way into the slot to ensure that the contacts are correctly inserted. The module is well inserted when its connection panel touches the metal chassis of the main device where inserted to.

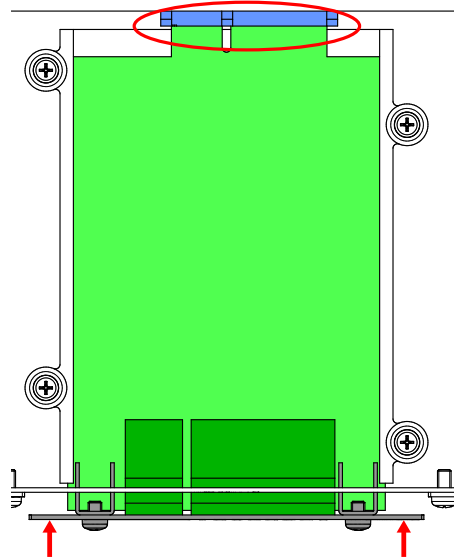

Step 5:

Fasten the module into the slot using the included screws. Be aware that damage or malfunctions may occur if the module is not correctly fastened.

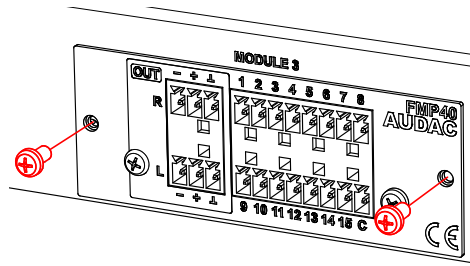

Step 6:

Repeat steps 3 to 5 for every additional module which needs to be installed. If all the modules are installed, the system can be powered-on and the modules will get automatically discovered.

Chapter 5

Additional information

IP Basics

Many AUDAC products are controllable by Ethernet. The Ethernet connection which is used on the AUDAC products is TCP/IP based, like 99% of the computer networks. There are some basics which you need to know to successfully make a TCP/IP Ethernet connection.

The data in TCP/IP networks is always sent in packages, all these packages must be delivered at a unique address, just like the mailman delivers mail at your home mailbox. In TCP/IP networks, this address is called the “IP address”. The IP address is always a number in the following format “192.168.000.001”. As you can see, this address consists of 4 separate numbers ranging from “000” to “255”.

In simple terms, only the latest number of an IP address can be different within a network, so there is a maximum of 254 unique addresses within a network, ranging from “xxx.xxx.xxx.001” to “xxx.xxx.xxx.254”. The first three numbers must be the same to make communication between several devices possible, else the devices can not communicate with each other.

Example:

Device 1:	IP address:	192.168.000.001
Device 2:	IP address:	192.168.000.002
Device 3:	IP address:	192.168.001.003

In this example, Device 1 can communicate with Device 2, but not with Device 3, because the first three numbers must be the same. These first three parts are called the “IP range”, so the devices must be in the same “IP range” to communicate with each other.

The “IP range” of home and office networks are defined by the network administrator, this means that the IP range of your home or office network can be different from another network. AUDAC products have the following IP address as default: “192.168.0.xxx”, this means the standard IP range of AUDAC products is “192.168.000.xxx”. If your network is using a different IP range, the AUDAC products will not be accessible from your network. You can change the IP address of the AUDAC products to make them work properly in your network. This can be done in the settings menu, and is described extensively in the “Settings” chapter of this user manual.

Ask your network administrator for help if you are not familiar with networks.

Summary

- All devices must have an unique IP address
- All devices must be within the same IP range

Technical specifications

Inputs	Type	4 x SourceCon™ interface card slots 4 x USB interface
Control		Front panel RS-232 TCP/IP Audac Touch™ Web (HTML5)
Frequency	Response (± 3 dB)	20 Hz – 20 kHz
Display	Type	2.8" Graphical LCD
Monitoring		Front PFL speaker with volume control
Power	Type	Switching mode
	Range	110–240V AC – 50/60 Hz
	Consumption	2 Watt (without module installed)
Operating temperature		0° ~ 40° @ 95% Humidity
Dimensions (W x H x D)		482 x 44 x 330 mm
	Unit height	1 HE
Weight		3.4 Kg
Compatible devices		DMP40 DAB/DAB+/FM tuner module FMP40 Voice file interface module IMP40 Internet radio module TMP40 FM tuner module
Optional internal modules		ANX44 Dante network audio interface 4 in / 4 out